

**V&V Valli&Valli**

**ASSA ABLOY**



# Door levers Cabinet hardware 13

ASSA ABLOY is the global leader in door opening solutions, dedicated to satisfying end-user needs for security, safety and convenience.

# Valli&Valli

## Mission

The handle, as conceived by Valli&Valli, has traditionally conveyed a home's style and functional elegance and, as a decorative object therein, will remain an important element of interior décor well into the future. Guided by this vision, Valli&Valli created V&V and Fusital, trademark collections recognized for their technological sophistication and signature contemporary aesthetic.

Valli&Valli is also united by a history of strong craftsmanship and innovation, principles that have made the company a leader in the creation of brass, Nikrall (a zinc alloy UNI 3717) and stainless steel materials, handles and other household accessories that are designed to satisfy both the formal and practical requirements of the end user.

## Origins

Nearly eighty years ago, Pasquale Valli secured a position at an umbrella factory in Veduggio, Italy, managing the department that oversaw the design and production of handles. While umbrellas of the time looked exactly the same-somber, dark and gloomy-the treatment reserved for the handle itself was wildly different. In Valli's design department, fancy took flight. The handle articulated the true personality of the umbrella and it was this piece that captured a buyer's attention. The importance of touch and the contact between a consumer and an innovatively designed object was an experience that Pasquale Valli valued immeasurably.

Valli learned many things from his time in the handle department. He absorbed an understanding of the properties and handling of metal, including fusion techniques, the use of molds and dyes and the techniques employed for various other materials, such as plastics. Fascinated with the ergonomic relationship between hand and object, he was compelled to study at a sculptor's studio, inciting a passion for art and commitment to artisanal craft methods. These experiences changed his life, inspiring him to become an entrepreneur.



# Index

## V&V

<b>Affordable Luxury</b>	page 19
<b>Code Handle</b>	page 22
<b>Door levers + Window levers</b>	page 28
<b>Door knobs</b>	page 73
<b>Door pulls</b>	page 77
<b>Coat hooks</b>	page 84
<b>Pocket doors</b>	page 88
<b>Door stopper</b>	page 105
<b>Cabinet pulls</b>	page 109
<b>Cabinet knobs</b>	page 130
<b>Mortise locks</b>	page 136
<b>Deadbolts, Privacy bolts</b>	page 145
<b>Escutcheon with deadbolts</b>	page 150
<b>Multi-point</b>	page 154
<b>Desipro program</b>	page 163
<b>Miscellaneous parts</b>	page 166
<b>Technical information</b>	page 174
<b>UNI EN ISO 9001:2008   ADA</b>	page 200
<b>General sales terms and conditions</b>	page 203

# Door levers/Maniglie

Material: solid brass and stainless steel



**H 163 Serie Sarissa**  
design Valli Workshop  
page 29



**H 165 Serie Germana**  
design Valli Workshop  
page 30



**H 174 Serie Altair**  
design Valli Workshop  
page 31



**H 176 Serie Spiga**  
design Valli Workshop  
page 32



**H 179 Serie Aida**  
design Matteo Thun  
page 33



**H 192 Serie Prunus**  
design Valli Workshop  
page 34



**H 195 Serie Orchidea**  
design Valli Workshop  
page 35



**H 198 Serie Mizar**  
design Eero Aarnio  
page 36



**H 412 Serie Lilla**  
design Valli Workshop  
page 37



**H 414 Serie Amber**  
design Valli Workshop  
page 38

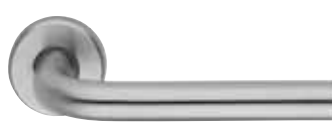

**H 415 Serie Scarlet**  
design Valli Workshop  
page 39



**H 416 Serie Garnet**  
design Valli Workshop  
page 40



**H 417 Serie Indigo**  
design Valli Workshop  
page 41



**H 419 Serie Bordeaux**  
design Valli Workshop  
page 42



**H 421 Serie Didone**  
design Piero Russi  
page 43



**H 1003 Serie Croco**  
design Matteo Thun  
page 44



**H 1004 Serie Antares**  
design Valli Workshop  
page 45



**H 1012 Serie Poliuto**  
design Valli Workshop  
page 46



**H 1015 Serie West**  
design Itamar Harari  
page 47



**H 1016 Serie Nabucco**  
design Valli Workshop  
page 48



**H 1017 Serie Camelia**  
design Matteo Thun  
page 49



**H 1018 Serie Otello**  
design Marius Schreyer Design  
page 50



**H 1022 Serie Ermani**  
design Valli Workshop  
page 51



**H 1024 Serie Lolita**  
design Valli Workshop  
page 52



**H 1026 Serie Dido**  
design Antonio Bullo  
page 53



**H 1027 Serie Dafne**  
design Studio Carlesi Design  
page 54



**H 1034 Serie Polis**  
design Decoma Design  
page 55



**H 1037 Serie Teseo**  
design Valli Workshop  
page 56

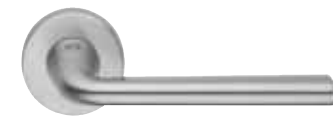

**H 1038 Serie Armida**  
design Decoma Design  
page 57



**H 1039 Serie Fedra**  
design Jean-Baptiste Sibertin Blanc  
page 58

# Door levers/Maniglie

Material: solid brass and stainless steel



**H 1042 Serie Walkiria**  
design Panacom Architects/Arsenyi Leonovich  
page 59



**H 1043 Serie Alcina**  
design Matteo Thun  
page 60



**H 1044 Serie Oberon**  
design Vincent Van Duysen  
page 61



**H 1045 Serie Bess**  
design Yoshimi Kono  
page 62



**H 1046 Serie Nais**  
design Valli Workshop  
page 63



**H 1049 Serie Divara**  
design Valli Workshop  
page 64



**H 1050 Serie Giasone**  
design Valli Workshop  
page 65



**H 1051 Serie Tieste**  
design Yoshimi Kono  
page 66



**H 4705 Serie Rhodamine**  
design Valli Workshop  
page 67



**H 4707 Serie Grey**  
design Valli Workshop  
page 68



**H 4730 Serie White**  
design Valli Workshop  
page 69



**H 4734 Serie Magenta**  
design Valli Workshop  
page 70



**H 4742 Serie Coral**  
design Valli Workshop  
page 71



**H 4744 Serie Artica**  
design Valli Workshop  
page 72

# Door knobs/Pomoli

Material: solid brass



**K 1168** Serie Giasone  
design Valli Workshop  
page 74



**K 4712**  
design Valli Workshop  
page 75



**K 4714**  
design Valli Workshop  
page 76

# Door pulls/Maniglioni

Material: solid brass



**K 1188**  
design Valli Workshop  
page 78



**K 1210** Serie Mizar  
design Eero Aarnio  
page 79



**K 1219**  
design Valli Workshop  
page 80



**K 1224**  
design Valli Workshop  
page 81



**K 1226** Serie Fedra  
design Jean Baptiste Sibertin Blanc  
page 82



**K 1228** Serie Bess  
design Yoshimi Kono  
page 83



# Coat hooks/Appendiabiti

Material: solid brass



**E 180**  
design Cini Boeri  
page 85



**E 182**  
design Valli Workshop  
page 85



**E 183**  
design Valli Workshop  
page 86



**E 525**  
design Valli Workshop  
page 86



**E 1009**  
design Valli Workshop  
page 87

# Pocket doors/Maniglie per incasso

Material: solid brass



## K 1186

design Valli Workshop  
page 90



## K 1195 Serie Bess

design Yoshimi Kono  
page 91



## K 1200 Serie Trittico

design Valli Workshop  
page 92



## K 1201 Serie Trittico

design Valli Workshop  
page 93

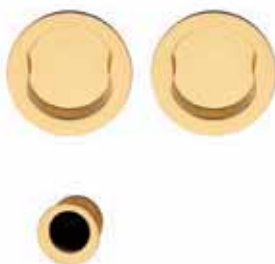

## K 1202 Serie Trittico

design Valli Workshop  
page 94



## K 1203 Serie Trittico

design Valli Workshop  
page 95

# Pocket doors/Maniglie per incasso

Material: solid brass

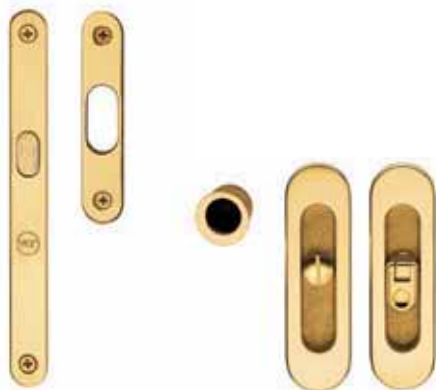

**K 1204 Serie Tancredi**  
design Valli Workshop  
page 96



**K 1205 Serie Tancredi**  
design Valli Workshop  
page 97



**K 1206 Serie Tancredi**  
design Valli Workshop  
page 98



**K 1211 Serie Orfeide**  
design Scigno  
page 99



**K 1212 Serie Orfeide**  
design Scigno  
page 100



**K 1230 Serie Bess**  
design Yoshimi Kono  
page 101

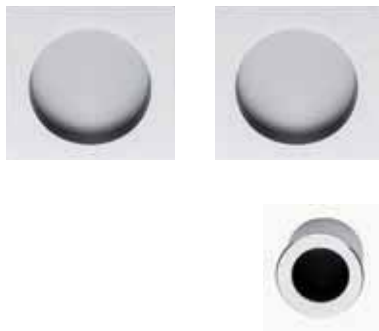

**K 1232 Serie Bess**  
design Yoshimi Kono  
page 102



**K 4200**  
page 103



**K 4202**  
page 104

# Door stopper/Fermaporta

Material: solid brass and stainless steel



**L 190**  
design Valli Workshop  
page 106



**L 193**  
design Valli Workshop  
page 106



**L 490**  
design Valli Workshop  
page 107

# Cabinet pulls

Material: solid brass, nikrall zamak alloy UNI 3717

All item not included in cabinet pulls, knobs are available on special request.



**A 163**  
design Sottsass Associati  
page 110



**A 230**  
design Valli Workshop  
page 110



**A 231**  
design Valli Workshop  
page 111



**A 237**  
design Eero Aarnio  
page 111



**A 240**  
design Eero Aarnio  
page 112



**A 252**  
design Eero Aarnio  
page 112



**A 256**  
design Eero Aarnio  
page 113



**A 275**  
design Valli Workshop  
page 113



**A 278**  
design Eero Aarnio  
page 114



**A 282**  
design Valli Workshop  
page 114



**A 283**  
design Valli Workshop  
page 115



**A 284**  
design Eero Aarnio  
page 115



**A 288**  
design Giancarlo Vegni  
page 116



**A 295**  
design Giancarlo Vegni  
page 116

# Cabinet pulls

Material: solid brass, nikrall zamak alloy UNI 3717

All item not included in cabinet pulls, knobs are available on special request.



**A 752/2**  
design Valli Workshop  
page 117



**A 753/2**  
design Valli Workshop  
page 117



**A 755/2**  
design Valli Workshop  
page 118



**A 791**  
design Valli Workshop  
page 119



**A 792**  
design Valli Workshop  
page 119



**A 2024**  
design Studio Carlesi Design  
page 120



**A 2025**  
design Antonio Citterio  
page 120



**A 2026**  
design Marianelli e Sordina  
page 121



**A 2027**  
design Giancarlo Vegni  
page 121



**A 2041**  
design Giancarlo Vegni  
page 122



**A 2042**  
design Frank O. Gehry  
page 122



**A 2046**  
design Carlesi Design  
page 123



**A 2047**  
design Giancarlo Vegni  
page 123



**A 2048**  
design Carlesi Design  
page 124

All item not included in cabinet pulls, knobs are available on special request.



**A 2050**  
design Carlsei Design  
page 124



**A 2057**  
design Valli Workshop  
page 125



**A 2061**  
design Valli Workshop  
page 126



**A 2062**  
design Valli Workshop  
page 127



**A 2068**  
design Michel Boucquillon  
page 128



# Cabinet knobs

Material: solid brass, nikrall zamak alloy UNI 3717



**B 33**  
design Gregotti Associati  
page 131



**B120**  
design Valli Workshop  
page 131



**B 128**  
design Valli Workshop  
page 132



**B 237**  
design Valli Workshop  
page 132



**B 239**  
design Gost&Schreyer  
page 133



**B 242**  
design Eero Aarnio  
page 133



**B 985**  
design Valli Workshop  
page 134



**B 985 PL**  
design Valli Workshop  
page 134

Affordable  
Luxury

# Affordable Luxury Door Handle

Valli&Valli Designs Under \$200 Retail Price

Pricing with Standard Round Rosette

H 412



H 414



H 415



H 416



H 417



H 421



H 1043



H 1044



H 4705



H 4707



H 4730



H 4734



H 4742



H 4744



K 4712



# Affordable Luxury Cabinet Hardware

Valli&Valli Designs Under \$30 Retail Price



ASSA ABLOY

A 163



A 237



A 240



A 278



A 284



A 752/2



A 753/2



A 755/2



A 791



A 792



A 2046



A 2062





## Contemporary electronic door handle

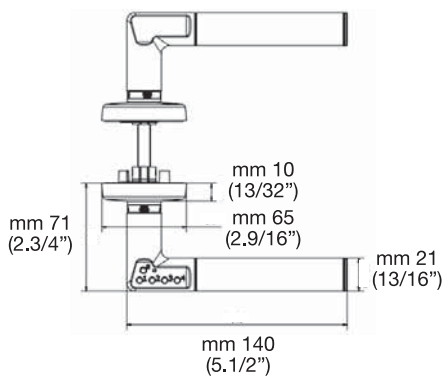

**Valli&Valli bring the comfort to your privacy, creating your own access to the door!**

Innovative code system handle. Door always closed from the outside, without any need for keys or locks. Access is permitted only with a digit personal code.

Practical and simple solution for offices, restaurants, personal archives, private office and other private spaces. Ideal for child security and protection from dangerous areas.



Homes • Retail stores • Private space • Spas • Restaurants • Offices

# The Code handle for doors

## Features

- A system to use for interior doors only
- Products is patented
- Material: brushed stainless steel and satin chrome zinc alloy for neutral and versatile aesthetic that is compatible with any space
- Powered by two lithium batteries inserted in the handle itself. Power will allow for approximately 100.000 openings. The system guarantees no memory loss in case of loss of power or during battery change
- Easy assembly: it does not require any wiring or special connections
- Includes special acoustic and optical alarm systems for easy and secure usage
- Available for both right and left opening, please specify
- No need for a Locksmith to change the lock
- No Building Maintenance necessary
- Need to change only the code

## How it works

- The locking mechanism is operated with five buttons
- Four buttons to press a four-to six digits code to unlock and one button to lock
- Green lights flashes and a sound is heard when the buttons are pressed for unlocking
- Red light flashes and a sound is heard when locking.
- Administration code and user code is programmed at installation, Can be changed unlimitedly
- Unique reset function (patent pending)
- If wrong code is pressed five times the handle is blocked for three minutes
- Free swing from the outside when locked, always possible to open with the handle from the inside.
- Indication for battery change
- The code is constant at voltage drop or battery change
- Batteries included
- Instructions on how to program are included in box

## Door handle available without code

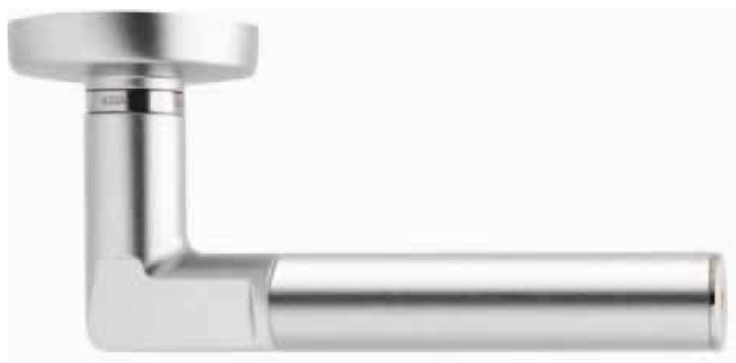

- Right-handed or Left-handed
- Same handle available through-out the building and home, Dummy function not available
- Coordinated accessories
- All other designs are available in the 2013 Valli&Valli and Fusital catalogs

### HOW TO ORDER

To order Valli&Valli products, informations should be specified in the same sequence as the example given:

1.Lever/Knob	2.Trim options	3.Function	4.Finish	5.Handing	6.Backset	7.List Price
H1931	RP	CODE	26D/32D	RH or LH	2-3/4"	\$440.00
H1931	RP	PGE	26D/32D	RH or LH	2-3/4"	\$359.00
H1931	RP	PCY	26D/32D	RH or LH	2-3/4"	\$385.00

HANDING - Must specify RH or LH

BACKSET - Must specify 2-3/8" or 2-3/4"

# Finishes

## U.S.A.

## ITALY

03 Polished Brass	03 Oro
03D Satin Brass	03D Orsatin
06 Antique Brass	06 Patiné
06A Anticato	06A Anticato
06B Brunito	06B Brunito
14 Polished Nickel	14 Nikpolish
15 Satin Nickel	15 Nikmatt
15A Antique Nickel	15A Niksatin
16 Dull Black	16 Neropaco
17 Orolux (brass finish)	17 Orolux
17D Satin Orolux	17D Orolux Matt
18 Light Black	18 Light Black
21 Black Enamel	21 Nero
22 White Enamel	22 Bianco
24 Gold 24K	24 Oro Zecchino
26 Polished Chrome	26 Cromo
26D Satin Chrome	26D Crowsatin
32 Polished Stainless Steel	32 Lucido
32D Satin Stainless Steel	32D Satinato

**Additional special finishes available on request on all products. Price subject to minimum upcharge of 25%.**

### HOW TO ORDER/Details page 24

To order Valli&Valli products, informations should be specified in the same sequence as the example given:

1.Lever/Knob	2.Trim options	3.Function	4.Finish	5.Handing	6.Backset	7.Miscellaneous
HXXX	RP	ML XX	03	RH	2.1/2"	2.1/4" thick

For small rosette, please specify RS/RSQ (45 mm rosette). RS pricing is the same as RP/RT pricing. Privacy RS also requires 105 RSP when ordering.

RQ (2.9/16" rosette) for standard 2.1/8" cross bore. RSQ pricing is the same as RQ. Privacy RSQ also requires 105 RSQ when ordering.

ET/EP = 03-26 Standard Finish, ER = 15-26-26D Standard Finish.

Conversion from metric to US measurement are approximate.

### V&V

Door levers and knobs, door pulls, decorative accessories, cabinet hardware,  
Stainless steel levers, knobs and door pulls.

# How to order: details

## 1. Lever or Knob

Choose from all Valli&Valli product lines

## 2. Trim Options

Choose from the following:

RT	standard traditional style rosette 7/16" (12mm) Top to bottom	RSS	small stainless steel rosette
RP	standard plain style rosette 3/8" (10mm) Top to bottom	RPS	standard stainless steel rosette
RQ	standard square style rosette 3/8" (10mm) Top to bottom	RQS	standard square rosette stainless steel
RS	small plain style rosette	ET	traditional style long escutcheon plate
RSM	small rosette multi point	EP	plain style long escutcheon plate
RST	small rosette traditional	ER	rectangular style long escutcheon plate
RSP	small rosette plain	ERS	rectangular style long escutcheon plate stainless steel
RSQ	small rosette square	NEP	narrow long escutcheon plate multi point
RSQS	small rosette square stainless steel	NES	narrow long escutcheon plate stainless steel multi point
RSSM	small stainless steel rosette-multi point	NER	narrow long rectangular escutcheon plate multi point
		NERS	narrow long rectangular escutcheon plate multi point stainless steel

## 3. Function

Choose from the following:

PGE	passage	103	long escutcheon plate with passage set and single cylinder deadbolt
PCY	privacy	104	long escutcheon plate with passage set and double cylinder deadbolt
DMY	dummy	105	privacy bolt
101	dead bolt single cylinder	106	long escutcheon plate with passage set and privacy bolt
102	dead bolt double cylinder	ML F	mortise lock
		MULTI-POINT TRIM	

## 4. Finish

Choose from stock or custom order finishes. Upcharge will apply.

06, 06A, 06B	Face/Strike supplied with 06/antique brass finish
15, 32D	Face/Strike supplied with 15/satin nickel finish
14, 26, 32	Face/Strike supplied with 26/polished chrome finish
26D	Face/Strike supplied with 26D/satin chrome finish

## 5. Handing

Follow the diagram on page 172.

## 6. Backset

2.3/8" = tubular (standard)  
2.3/4" = mortise (standard)  
Specify for all non-standard backsets.

## 7. Miscellaneous

Note special door thickness, keying information, split finishes.  
Note: Additional charges apply to these special details. See pricing list below.

**UL** Tubular Passage Latch available upon request.

### RUSH DELIVERY CHARGES \$ 25.00 NET

Applies to all orders requested to be shipped within 48 hrs.

### Drop ship charge = \$5.00 net

Applied to all drop ship orders

### KEYING CHARGES

Code #	Description (5 pin)	
KA	Keyed alike	No charge
KD	Keyed different	No charge
MK	Master keyed	Call factory for a quotation

Other keying options available upon request.

### CHARGES EXTRA THICK DOORS

\$ 50.00	2.1/4" thick door for tubular latch
\$ 70.00	2.1/2" thick door for tubular latch
\$ 90.00	3" thick doors for tubular latch
\$ 70.00	2.1/4" thick door for mortise lock
\$ 90.00	2.1/2" thick door for mortise lock
\$ 120.00	3" thick door for mortise lock

### DUMMY SET ADAPTOR/ See page 176

For 2.1/8" Pre-drilled doors  
X003/1 Back to back application  
X003/2 Single application  
Add to retail price

### Split Finishes and Non-Standard Rosettes add to Retail Price

\$ 20.00	Split finishes add to the highest priced finish used.
\$ 100.00	non standard RQ square rosette list to the highest priced finish used.
\$ 120.00	non standard RQS square stainless rosette list to the highest priced finish used.
\$ 100.00	non standard ER Rectangular escutcheon list to the highest priced finish used.
\$ 100.00	non standard RSQ (45 mm rose) list to the highest priced finish used.

Knobs cannot be mounted on ER escutcheon.



# Rosette options



**RP Rosette Plain Solid brass**  
**RPS Rosette Plain Stainless steel**  
65 mm (2.9/16")



**RQ Rosette Square Solid brass**  
**RQS Rosette Square Stainless steel**  
65 mm (2.9/16")



**RT Rosette Traditional Solid brass**  
65 mm (2.9/16")



**RS Small Rosette Solid brass**  
45 mm (1.3/4")



**RSS Small Rosette Stainless steel**  
50 mm (2")



**RSQ Small Rosette Square Solid brass**  
45 mm (1.3/4")

# Escutcheon plate options



60 mm (2.3/8")

**EP Plain Escutcheon  
Solid brass**

Plain escutcheon shown  
with thumbturn bolt  
60 mm (2.3/8")



57 mm (2.1/4")

**ET Traditional Escutcheon  
Solid brass**

Traditional escutcheon shown  
with thumbturn bolt  
57 mm (2.1/4")



65 mm (2.9/16")

**ER Rectangular Escutcheon Solid brass  
ERS Rectangular Escutcheon  
Stainless steel**

65 mm (2.9/16")



38 mm (1.1/2")

**NEP Narrow Plain  
Escutcheon Solid brass**

38 mm (1.1/2")



50 mm (2")

**NES Narrow Escutcheon  
Stainless steel**

50 mm (2")



38 mm (1.1/2")

**NER Narrow Rectangular  
Escutcheon Solid brass**

38 mm (1.1/2")



50 mm (2")

**NERS Narrow Rectangular  
Escutcheon Stainless steel**

50 mm (2")

Door levers/  
Maniglie

# H 163 Serie Sarissa

design Valli Workshop



ASSA ABLOY

## Matching elements/Coordinato

- Pg 135** Mortise lock functions
- Pg 144** Deadbolts/Privacy Bolts
- Pg 149** Escutcheons with deadbolts
- Pg 153** Multi-Point Trim functions



## Sizes/Misure

### Window handle/Maniglia per finestra H 163 F RS<sup>1</sup>

Movement 4 click positions

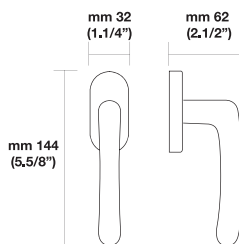
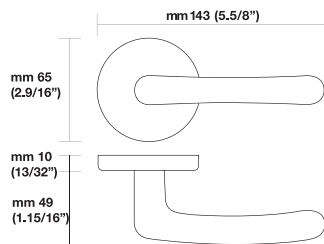



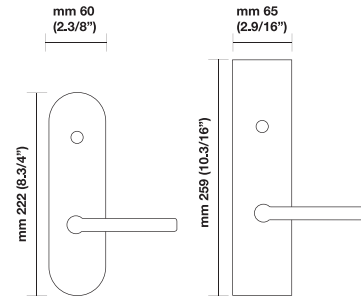







### Escutcheon options/Opzioni EP ER



Conversions from metric to U.S. measurements are approximate.  
<sup>1</sup>Call for pricing.

## Retail Price

Finish			PGE	PCY	DMY R/L Single	ML-F ENTRY
	03	RP	\$ 221.00	\$ 241.00	\$ 102.00	\$ 759.00
	06B	RP	\$ 229.00	\$ 255.00	\$ 105.00	\$ 759.00
	26	RP	\$ 221.00	\$ 241.00	\$ 102.00	\$ 759.00
	26D	RP	\$ 262.00	\$ 272.00	\$ 121.00	\$ 759.00

Finish			PGE	PCY	DMY R/L Single	DMY R/L Pair	ML-F ENTRY
	03	EP	\$ 386.00	\$ 407.00	\$ 185.00	\$ 330.00	\$ 670.00
	26	EP	\$ 386.00	\$ 407.00	\$ 185.00	\$ 330.00	\$ 670.00
		ER	\$ 453.00	\$ 457.00	\$ 218.00	\$ 393.00	\$ 699.00
	26D	EP	\$ 412.00	\$ 430.00	\$ 199.00	\$ 354.00	\$ 670.00
		ER	\$ 453.00	\$ 457.00	\$ 218.00	\$ 393.00	\$ 699.00

# H 165 Serie Germana

design Valli Workshop

Material Brass/Materiale Ottone

## Matching elements/Coordinato

- Pg 135** Mortise lock functions
- Pg 144** Deadbolts/Privacy Bolts
- Pg 149** Escutcheons with deadbolts
- Pg 153** Multi-Point Trim functions



## Sizes/Misure

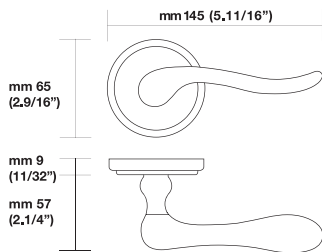

## Window handle/Maniglia per finestra H 165 F RS<sup>1</sup>

Movement 4 click positions

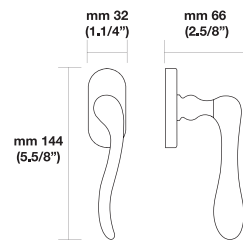



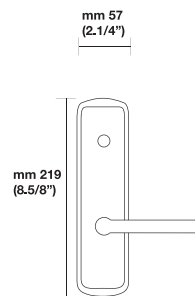





## Escutcheon options/Opzioni ET



Conversions from metric to U.S. measurements are approximate.  
<sup>1</sup>Call for pricing.

## Retail Price

Finish			PGE	PCY	DMY R/L Single	ML-F ENTRY
	03	<b>RT</b>	\$ 282.00	\$ 299.00	\$ 130.00	\$ 820.00
	03D	<b>RT</b>	\$ 282.00	\$ 299.00	\$ 130.00	\$ 820.00
	06A	<b>RT</b>	\$ 295.00	\$ 308.00	\$ 136.00	\$ 820.00

Finish			PGE	PCY	DMY R/L Single	DMY R/L Pair	ML-F ENTRY
	03	<b>ET</b>	\$ 453.00	\$ 484.00	\$ 218.00	\$ 397.00	\$ 725.00
	03D	<b>ET</b>	\$ 453.00	\$ 484.00	\$ 218.00	\$ 397.00	\$ 725.00

# H 174 Serie Altair

design Valli Workshop



ASSA ABLOY

Material Brass/Materiale Ottone

## Matching elements/Coordinato

- Pg 135** Mortise lock functions
- Pg 144** Deadbolts/Privacy Bolts
- Pg 149** Escutcheons with deadbolts
- Pg 153** Multi-Point Trim functions



## Sizes/Misure

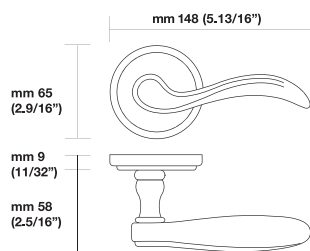

## Window handle/Maniglia per finestra H 174 F RS<sup>1</sup>

Movement 4 click positions

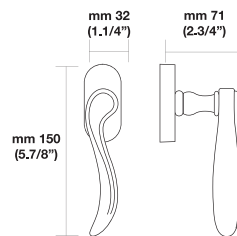

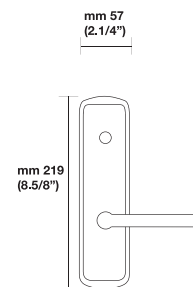

## Escutcheon options/Opzioni ET





Conversions from metric to U.S. measurements are approximate.  
<sup>1</sup>Call for pricing.

## Retail Price

Finish			PGE	PCY	DMY R/L Single	ML-F ENTRY
	03	RT	\$ 346.00	\$ 365.00	\$ 162.00	\$ 820.00

Finish		PGE	PCY	DMY R/L Single	DMY R/L Pair	ML-F ENTRY	
	03	ET	\$ 515.00	\$ 536.00	\$ 247.00	\$ 451.00	\$ 725.00

# H 176 Serie Spiga

design Valli Workshop

Material Brass/Materiale Ottone

## Matching elements/Coordinato

- Pg 135** Mortise lock functions
- Pg 144** Deadbolts/Privacy Bolts
- Pg 149** Escutcheons with deadbolts
- Pg 153** Multi-Point Trim functions



## Sizes/Misure

### Window handle/Maniglia per finestra

#### H 176 F RS<sup>1</sup>

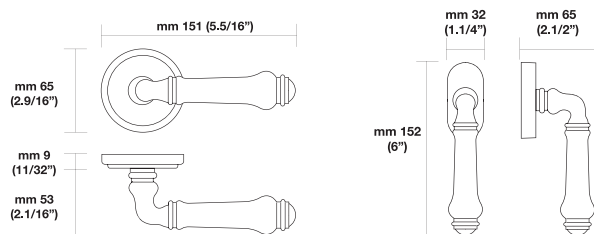

Movement 4 click positions



Conversions from metric to U.S. measurements are approximate.

<sup>1</sup>Call for pricing.

## Retail Price

Finish			PGE	PCY	DMY R/L Single	ML-F ENTRY
 06B/Ivory	<b>RT</b>		\$ 349.00	\$ 370.00	\$ 165.00	\$ 820.00

**NOTE:** Not available with long escutcheon

# H 179 Serie Aida

design Matteo Thun

Material Brass/Materiale Ottone



ASSA ABLOY

## Matching elements/Coordinato

- Pg 135** Mortise lock functions
- Pg 144** Deadbolts/Privacy Bolts
- Pg 149** Escutcheons with deadbolts
- Pg 153** Multi-Point Trim functions



## Sizes/Misure

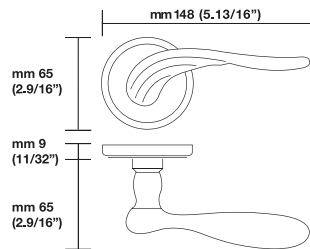

## Window handle/Maniglia per finestra

**H 179 F RS<sup>1</sup>**  
Movement 4 click positions

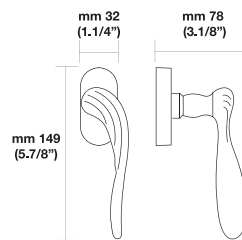



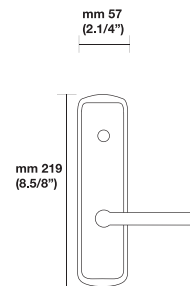



## Escutcheon options/Opzioni ET



Conversions from metric to U.S. measurements are approximate.  
<sup>1</sup>Call for pricing.

## Retail Price

Finish			PGE	PCY	DMY R/L Single	ML-F ENTRY	
 03	<b>RT</b>		\$ 347.00	\$ 368.00	\$ 162.00	\$ 820.00	
Finish			PGE	PCY	DMY R/L Single	DMY R/L Pair	ML-F ENTRY
 03	<b>ET</b>		\$ 510.00	\$ 536.00	\$ 247.00	\$ 453.00	\$ 725.00



# H 192 Serie Prunus

design Valli Workshop

Material Brass/Materiale Ottone

## Matching elements/Coordinato

- Pg 135** Mortise lock functions
- Pg 144** Deadbolts/Privacy Bolts
- Pg 149** Escutcheons with deadbolts
- Pg 153** Multi-Point Trim functions



## Sizes/Misure

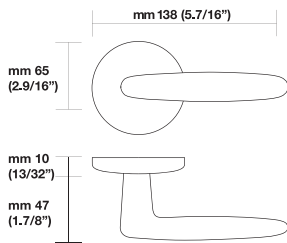

## Window handle/Maniglia per finestra H 192 F RS<sup>1</sup>

Movement 4 click positions

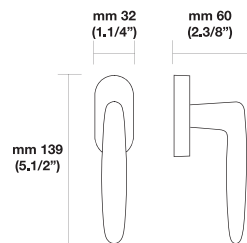



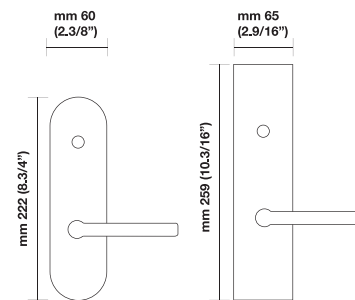

## Escutcheon options/Opzioni EP ER



Conversions from metric to U.S. measurements are approximate.  
<sup>1</sup>Call for pricing.

## Retail Price

Finish			PGE	PCY	DMY R/L Single	DMY R/L Pair	ML-F ENTRY
15	RP		\$ 246.00	\$ 260.00	\$ 113.00		\$ 759.00
Finish			PGE	PCY	DMY R/L Single	DMY R/L Pair	ML-F ENTRY
15	EP		\$ 412.00	\$ 430.00	\$ 199.00	\$ 354.00	\$ 670.00
		ER	\$ 453.00	\$ 457.00	\$ 218.00	\$ 393.00	\$ 699.00

# H 195 Serie Orchidea

design Valli Workshop

Material Brass/Materiale Ottone



ASSA ABLOY

## Matching elements/Coordinato

- Pg 135** Mortise lock functions
- Pg 144** Deadbolts/Privacy Bolts
- Pg 149** Escutcheons with deadbolts
- Pg 153** Multi-Point Trim functions



## Sizes/Misure

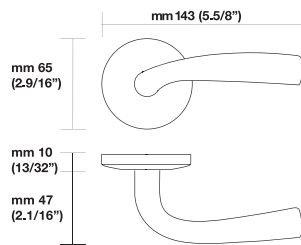

## Window handle/Maniglia per finestra H 195 F RS<sup>1</sup>

Movement 4 click positions

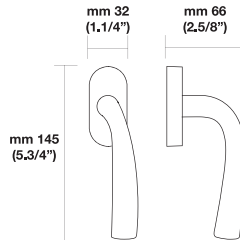



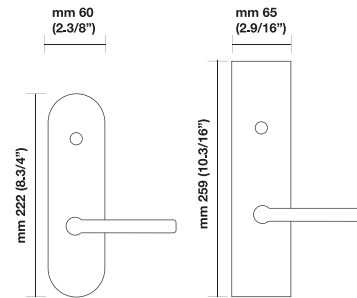

## Escutcheon options/Opzioni EP ER



Conversions from metric to U.S. measurements are approximate.

<sup>1</sup>Call for pricing.

## Retail Price

Finish			PGE	PCY	DMY R/L Single		ML-F ENTRY
26D	<b>RP</b>		\$ 241.00	\$ 253.00	\$ 111.00		\$ 759.00
Finish			PGE	PCY	DMY R/L Single	DMY R/L Pair	ML-F ENTRY
26D	<b>EP</b>		\$ 411.00	\$ 431.00	\$ 196.00	\$ 350.00	\$ 670.00
		<b>ER</b>	\$ 453.00	\$ 457.00	\$ 218.00	\$ 393.00	\$ 699.00

# H 198 Serie Mizar

design Eero Aarnio

Material Brass/Materiale Ottone

## Matching elements/Coordinato

- Pg 135** Mortise lock functions
- Pg 144** Deadbolts/Privacy Bolts
- Pg 149** Escutcheons with deadbolts
- Pg 153** Multi-Point Trim functions



## Sizes/Misure

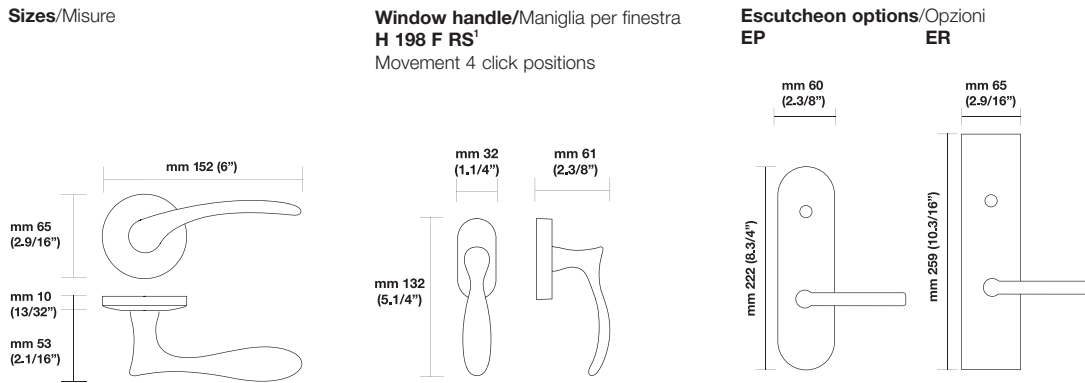













**Window handle/Maniglia per finestra  
H 198 F RS<sup>1</sup>**  
Movement 4 click positions

**Escutcheon options/Opzioni  
EP ER**

Conversions from metric to U.S. measurements are approximate.  
<sup>1</sup>Call for pricing.

## Retail Price

Finish		PGE	PCY	DMY R/L Single	ML-F ENTRY
	03 <b>RP</b>	\$ 258.00	\$ 277.00	\$ 119.00	\$ 759.00
	03D <b>RP</b>	\$ 258.00	\$ 277.00	\$ 119.00	\$ 759.00
	06A <b>RP</b>	\$ 290.00	\$ 308.00	\$ 136.00	\$ 759.00
	14 <b>RP</b>	\$ 288.00	\$ 304.00	\$ 135.00	\$ 759.00
	15 <b>RP</b>	\$ 278.00	\$ 288.00	\$ 128.00	\$ 759.00
	26D <b>RP</b>	\$ 270.00	\$ 284.00	\$ 126.00	\$ 759.00

Finish		PGE	PCY	DMY R/L Single	DMY R/L Pair	ML-F ENTRY
	03 <b>EP</b>	\$ 422.00	\$ 443.00	\$ 205.00	\$ 365.00	\$ 670.00
	03D <b>EP</b>	\$ 422.00	\$ 443.00	\$ 205.00	\$ 365.00	\$ 670.00
	<b>EP</b>	\$ 412.00	\$ 430.00	\$ 199.00	\$ 354.00	\$ 670.00
	<b>ER</b>	\$ 453.00	\$ 457.00	\$ 218.00	\$ 393.00	\$ 699.00
	<b>EP</b>	\$ 412.00	\$ 430.00	\$ 199.00	\$ 354.00	\$ 670.00
	<b>ER</b>	\$ 453.00	\$ 457.00	\$ 218.00	\$ 393.00	\$ 699.00

# H 412 Serie Lilla

design Valli Workshop



ASSA ABLOY

Material Brass/Materiale Ottone

## Matching elements/Coordinato

- Pg 135** Mortise lock functions
- Pg 144** Deadbolts/Privacy Bolts
- Pg 149** Escutcheons with deadbolts
- Pg 153** Multi-Point Trim functions



## Sizes/Misure

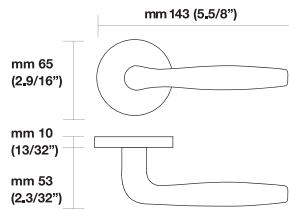

## Window handle/Maniglia per finestra H 412 F RS<sup>1</sup> Movement 4 click positions

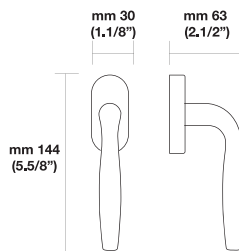

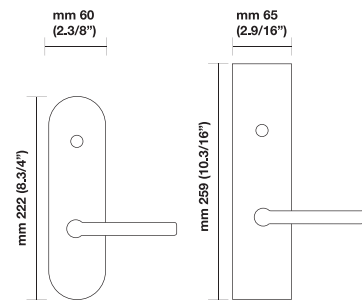

## Escutcheon options/Opzioni EP ER





Conversions from metric to U.S. measurements are approximate.  
<sup>1</sup>Call for pricing.

## Retail Price

Finish			PGE	PCY	DMY R/L Single	ML-F ENTRY
26D	<b>RP</b>		\$ 180.00	\$ 197.00	\$ 90.00	\$ 734.00

Finish			PGE	PCY	DMY R/L Single	DMY R/L Pair	ML-F ENTRY
26D	<b>EP</b>		\$ 355.00	\$ 373.00	\$ 182.00	\$ 319.00	\$ 640.00
		<b>ER</b>	\$ 431.00	\$ 442.00	\$ 207.00	\$ 371.00	\$ 670.00

# H 414 Serie Amber

design Valli Workshop

Material Stainless steel AISI 304/Materiale Acciaio Inox AISI 304

## Matching elements/Coordinato

- Pg 135** Mortise lock functions
- Pg 144** Deadbolts/Privacy Bolts
- Pg 149** Escutcheons with deadbolts
- Pg 153** Multi-Point Trim functions



## Sizes/Misure

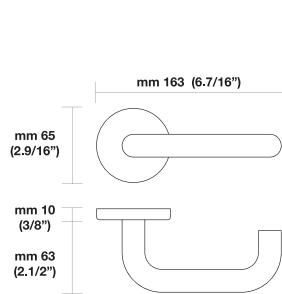

## Window handle/Maniglia per finestra H 414 F RS<sup>1</sup>

Movement 4 click positions

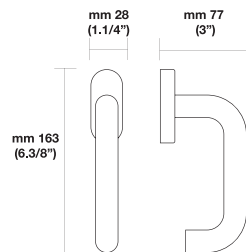



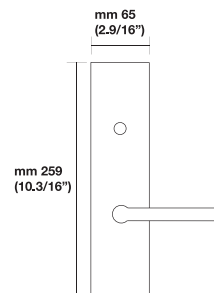

## Escutcheon options/Opzioni ERS



Conversions from metric to U.S. measurements are approximate.  
<sup>1</sup>Call for pricing.

## Retail Price

Finish			PGE	PCY	DMY R/L Single	ML-F ENTRY	
32D	<b>RPS</b>		\$ 152.00	\$ 168.00	\$ 80.00	\$ 926.00	
Finish			PGE	PCY	DMY R/L Single	DMY R/L Pair	ML-F ENTRY
32D	<b>ERS</b>		\$ 440.00	\$ 445.00	\$ 221.00	\$ 402.00	\$ 747.00

# H 415 Serie Scarlet

design Valli Workshop



ASSA ABLOY

Material Stainless steel AISI 304/Materiale Acciaio Inox AISI 304

## Matching elements/Coordinato

- Pg 135** Mortise lock functions
- Pg 144** Deadbolts/Privacy Bolts
- Pg 149** Escutcheons with deadbolts
- Pg 153** Multi-Point Trim functions



## Sizes/Misure

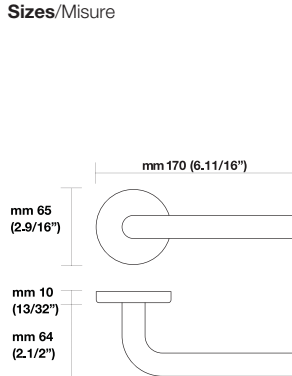

## Window handle/Maniglia per finestra H 415 F RS<sup>1</sup> Movement 4 click positions

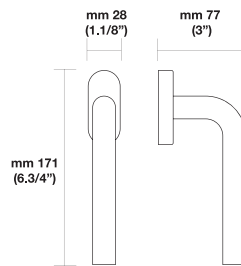



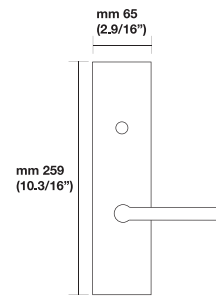

## Escutcheon options/Opzioni ERS



Conversions from metric to U.S. measurements are approximate.

<sup>1</sup>Call for pricing.

## Retail Price

Finish			PGE	PCY	DMY R/L Single	ML-F ENTRY	
32D	<b>RPS</b>		\$ 152.00	\$ 168.00	\$ 80.00	\$ 926.00	
Finish			PGE	PCY	DMY R/L Single	DMY R/L Pair	ML-F ENTRY
32D	<b>ERS</b>		\$ 440.00	\$ 445.00	\$ 221.00	\$ 402.00	\$ 747.00

# H 416 Serie Garnet

design Valli Workshop

Material Stainless steel AISI 304/Materiale Acciaio Inox AISI 304

## Matching elements/Coordinato

- Pg 135** Mortise lock functions
- Pg 144** Deadbolts/Privacy Bolts
- Pg 149** Escutcheons with deadbolts
- Pg 153** Multi-Point Trim functions



## Sizes/Misure

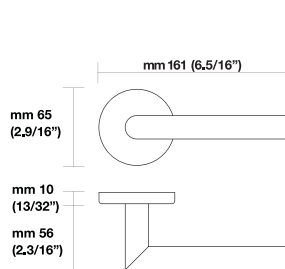

## Window handle/Maniglia per finestra H 416 F RS<sup>1</sup> Movement 4 click positions

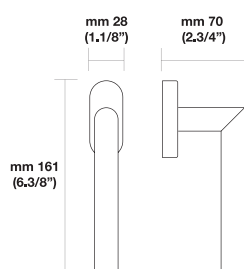

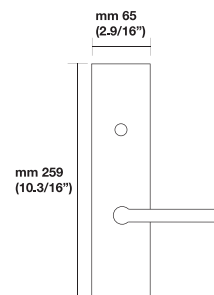

## Escutcheon options/Opzioni ERS





Conversions from metric to U.S. measurements are approximate.  
<sup>1</sup>Call for pricing.

## Retail Price

Finish			PGE	PCY	DMY R/L Single	ML-F ENTRY
32D	<b>RPS</b>		\$ 152.00	\$ 168.00	\$ 80.00	\$ 926.00

Finish			PGE	PCY	DMY R/L Single	DMY R/L Pair	ML-F ENTRY
32D	<b>ERS</b>		\$ 440.00	\$ 445.00	\$ 221.00	\$ 402.00	\$ 747.00

# H 417 Serie Indigo

design Valli Workshop



ASSA ABLOY

Material Nikrall Zamak alloy UNI 3717/Materiale Nikrall Lega Zama UNI 3717

## Matching elements/Coordinato

- Pg 135** Mortise lock functions
- Pg 144** Deadbolts/Privacy Bolts
- Pg 149** Escutcheons with deadbolts
- Pg 153** Multi-Point Trim functions



## Sizes/Misure

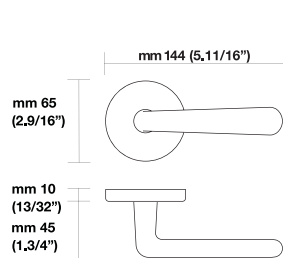

## Window handle/Maniglia per finestra H 417 F RS<sup>1</sup>

Movement 4 click positions

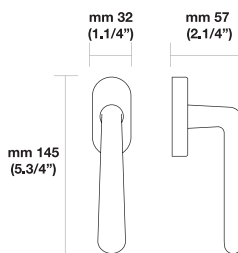



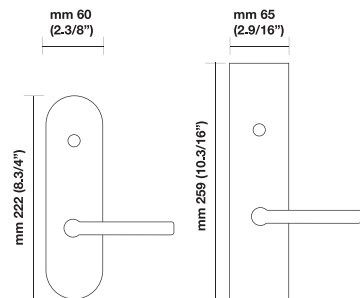

## Escutcheon options/Opzioni EP ER



Conversions from metric to U.S. measurements are approximate.  
<sup>1</sup>Call for pricing.

## Retail Price

Finish			PGE	PCY	DMY R/L Single	ML-F ENTRY	
26D	<b>RP</b>		\$ 196.00	\$ 199.00	\$ 99.00	\$ 734.00	
Finish			PGE	PCY	DMY R/L Single	DMY R/L Pair	ML-F ENTRY
26D	<b>EP</b>		\$ 360.00	\$ 393.00	\$ 197.00	\$ 335.00	\$ 640.00
		<b>ER</b>	\$ 431.00	\$ 442.00	\$ 207.00	\$ 371.00	\$ 670.00



# H 419 Serie Bordeaux

design Valli Workshop

Material Stainless steel AISI 304/Materiale Acciaio Inox AISI 304

## Matching elements/Coordinato

- Pg 135** Mortise lock functions
- Pg 144** Deadbolts/Privacy Bolts
- Pg 149** Escutcheons with deadbolts
- Pg 153** Multi-Point Trim functions

## Rosette options/Opzioni RPS

mm 65  
(2.9/16")

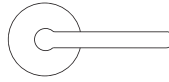

## Sizes/Misure

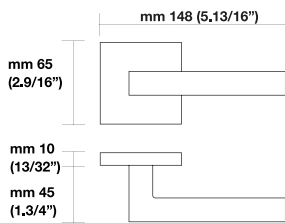

## Window handle/Maniglia per finestra H 419 F RS<sup>1</sup>

Movement 4 click positions

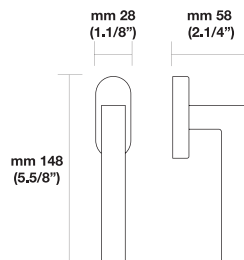



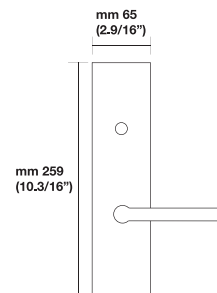

## Escutcheon options/Opzioni ERS



Conversions from metric to U.S. measurements are approximate.  
<sup>1</sup>Call for pricing.

## Retail Price

Finish			PGE	PCY	DMY R/L Single	DMY R/L Pair	ML-F ENTRY
32D	<b>RPS</b>		\$ 235.00	\$ 250.00	\$ 120.00		\$ 926.00
	<b>RQS</b>		\$ 367.00	\$ 398.00	\$ 190.00		\$ 901.00
Finish			PGE	PCY	DMY R/L Single	DMY R/L Pair	ML-F ENTRY
32D	<b>ERS</b>		\$ 440.00	\$ 445.00	\$ 221.00	\$ 402.00	\$ 747.00

# H 421 Serie Didone

design Piero Russi

Material Nikrall Zamak Alloy UNI1317/Materiale Lege Zama



ASSA ABLOY

## Matching elements/Coordinato

- Pg 135** Mortise lock functions
- Pg 144** Deadbolts/Privacy Bolts
- Pg 149** Escutcheons with deadbolts
- Pg 153** Multi-Point Trim functions



## Sizes/Misure

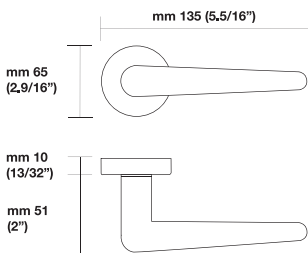

## Window handle/Maniglia per finestra H 421 F RS<sup>1</sup>

Movement 4 click positions

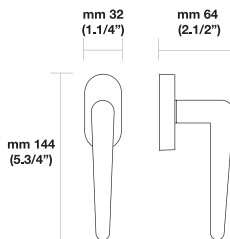



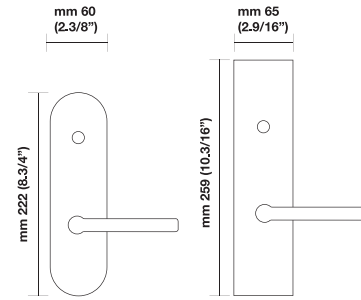





## Escutcheon options/Opzioni EP ER



Conversions from metric to U.S. measurements are approximate.  
<sup>1</sup>Call for pricing.

## Retail Price

Finish			PGE	PCY	DMY		ML-F
					R/L Single		ENTRY
	26	<b>RP</b>	\$ 156.00	\$ 176.00	\$ 80.00		\$ 734.00
	26D	<b>RP</b>	\$ 160.00	\$ 180.00	\$ 82.00		\$ 734.00
Finish			PGE	PCY	DMY	DMY	ML-F
					R/L Single	R/L Pair	ENTRY
	26	<b>EP</b>	\$ 360.00	\$ 393.00	\$ 197.00	\$ 335.00	\$ 640.00
		<b>ER</b>	\$ 431.00	\$ 442.00	\$ 207.00	\$ 371.00	\$ 670.00
	26D	<b>EP</b>	\$ 360.00	\$ 393.00	\$ 197.00	\$ 335.00	\$ 640.00
		<b>ER</b>	\$ 431.00	\$ 442.00	\$ 207.00	\$ 371.00	\$ 670.00

# H 1003 Serie Croco

design Matteo Thun

Material Brass/Materiale Ottone

## Matching elements/Coordinato

- Pg 135** Mortise lock functions
- Pg 144** Deadbolts/Privacy Bolts
- Pg 149** Escutcheons with deadbolts
- Pg 153** Multi-Point Trim functions



## Sizes/Misure

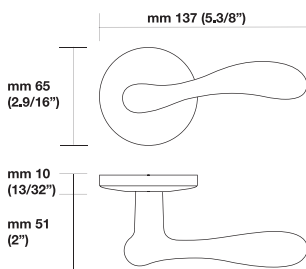

## Window handle/Maniglia per finestra H 1003 F RS<sup>1</sup>

Movement 4 click positions

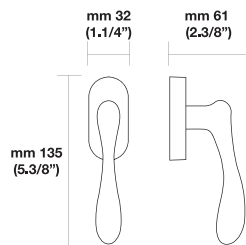



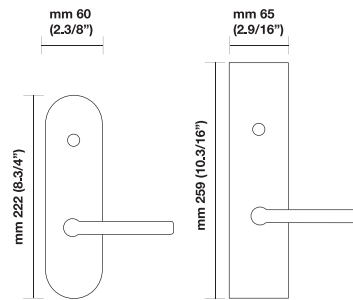













## Escutcheon options/Opzioni EP ER



Conversions from metric to U.S. measurements are approximate.  
<sup>1</sup>Call for pricing.

## Retail Price

Finish			PGE	PCY	DMY R/L Single	ML-F ENTRY
	03	RP	\$ 234.00	\$ 251.00	\$ 107.00	\$ 759.00
	03D	RP	\$ 234.00	\$ 251.00	\$ 107.00	\$ 759.00
	06A	RP	\$ 260.00	\$ 282.00	\$ 121.00	\$ 759.00
	14	RP	\$ 260.00	\$ 282.00	\$ 121.00	\$ 759.00
	15	RP	\$ 252.00	\$ 265.00	\$ 115.00	\$ 759.00
	26D	RP	\$ 249.00	\$ 260.00	\$ 114.00	\$ 759.00
	26/26D	RP	\$ 249.00	\$ 260.00	\$ 114.00	\$ 759.00

Finish			PGE	PCY	DMY R/L Single	DMY R/L Pair	ML-F ENTRY
	03	EP	\$ 402.00	\$ 433.00	\$ 194.00	\$ 354.00	\$ 670.00
	03D	EP	\$ 402.00	\$ 433.00	\$ 194.00	\$ 354.00	\$ 670.00
	15	EP	\$ 412.00	\$ 430.00	\$ 199.00	\$ 354.00	\$ 670.00
		ER	\$ 453.00	\$ 457.00	\$ 218.00	\$ 393.00	\$ 699.00
	26D	EP	\$ 412.00	\$ 430.00	\$ 199.00	\$ 354.00	\$ 670.00
		ER	\$ 453.00	\$ 457.00	\$ 218.00	\$ 393.00	\$ 699.00
	26/26D	EP	\$ 412.00	\$ 430.00	\$ 199.00	\$ 354.00	\$ 670.00
		ER	\$ 453.00	\$ 457.00	\$ 218.00	\$ 393.00	\$ 699.00

# H 1004 Serie Antares

design Valli Workshop

Material Brass/Materiale Ottone



ASSA ABLOY

## Matching elements/Coordinato

- Pg 135** Mortise lock functions
- Pg 144** Deadbolts/Privacy Bolts
- Pg 149** Escutcheons with deadbolts
- Pg 153** Multi-Point Trim functions



## Sizes/Misure

### Window handle/Maniglia per finestra

#### H 1004 F RS<sup>1</sup>

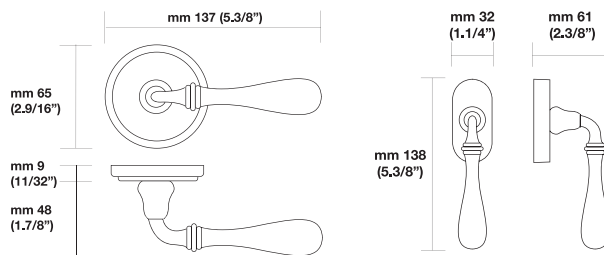

Movement 4 click positions



Conversions from metric to U.S. measurements are approximate.

<sup>1</sup>Call for pricing.

## Retail Price

Finish			PGE	PCY	DMY R/L Single	ML-F ENTRY
	06B	RT	\$ 211.00	\$ 237.00	\$ 101.00	\$ 759.00

**NOTE:** Not available on ER/EP/ET escutcheon.

# H 1012 Serie Poliuto

design Valli Workshop

Material Brass/Materiale Ottone

## Matching elements/Coordinato

- Pg 135** Mortise lock functions
- Pg 144** Deadbolts/Privacy Bolts
- Pg 149** Escutcheons with deadbolts
- Pg 153** Multi-Point Trim functions



## Sizes/Misure

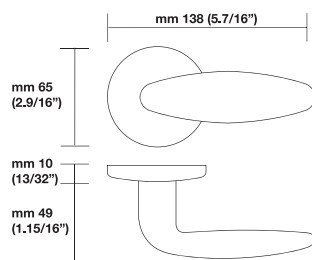

## Window handle/Maniglia per finestra H 1012 F RS<sup>1</sup> Movement 4 click positions

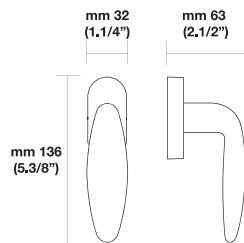



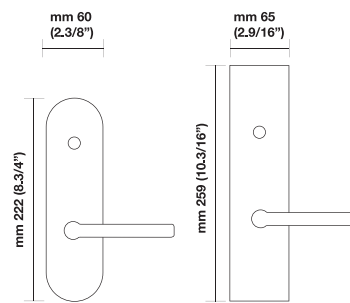

## Escutcheon options/Opzioni EP ER



Conversions from metric to U.S. measurements are approximate.  
<sup>1</sup>Call for pricing.

## Retail Price

Finish			PGE	PCY	DMY R/L Single	DMY R/L Pair	ML-F ENTRY
26D	RP		\$ 282.00	\$ 299.00	\$ 132.00		\$ 759.00
Finish			PGE	PCY	DMY R/L Single	DMY R/L Pair	ML-F ENTRY
26D	EP		\$ 412.00	\$ 430.00	\$ 199.00	\$ 354.00	\$ 670.00
		ER	\$ 453.00	\$ 457.00	\$ 218.00	\$ 393.00	\$ 699.00

# H 1015 Serie West

design Itamar Harari

Material Brass/Materiale Ottone



ASSA ABLOY

## Matching elements/Coordinato

- Pg 135** Mortise lock functions
- Pg 144** Deadbolts/Privacy Bolts
- Pg 149** Escutcheons with deadbolts
- Pg 153** Multi-Point Trim functions



## Sizes/Misure

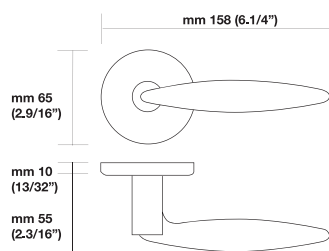

## Window handle/Maniglia per finestra H 1015 F RS<sup>1</sup>

Movement 4 click positions

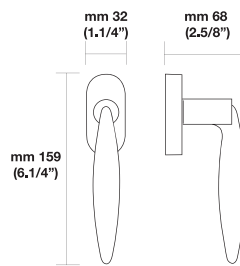



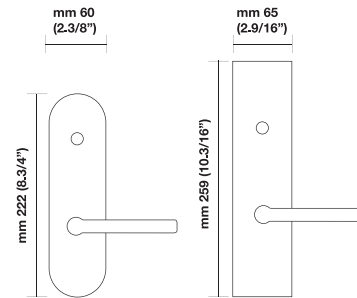





## Escutcheon options/Opzioni EP ER



Conversions from metric to U.S. measurements are approximate.

<sup>1</sup>Call for pricing.

## Retail Price

Finish			PGE	PCY	DMY R/L Single	ML-F ENTRY	
	03/03D	RP	\$ 283.00	\$ 302.00	\$ 132.00	\$ 820.00	
	26/26D	RP	\$ 294.00	\$ 304.00	\$ 136.00	\$ 820.00	
Finish			PGE	PCY	DMY R/L Single	DMY R/L Pair	ML-F ENTRY
	03/03D	EP	\$ 443.00	\$ 464.00	\$ 216.00	\$ 386.00	\$ 725.00
	26/26D	EP	\$ 453.00	\$ 474.00	\$ 218.00	\$ 391.00	\$ 725.00
		ER	\$ 503.00	\$ 507.00	\$ 245.00	\$ 447.00	\$ 760.00

# H 1016 Serie Nabucco

design Valli Workshop

Material Brass/Materiale Ottone

## Matching elements/Coordinato

- Pg 135** Mortise lock functions
- Pg 144** Deadbolts/Privacy Bolts
- Pg 149** Escutcheons with deadbolts
- Pg 153** Multi-Point Trim functions



## Sizes/Misure

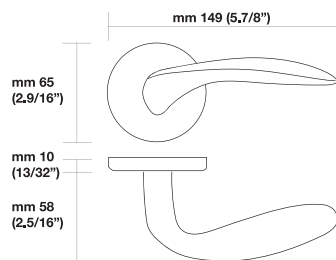

## Window handle/Maniglia per finestra H 1016 F RS<sup>†</sup>

Movement 4 click positions

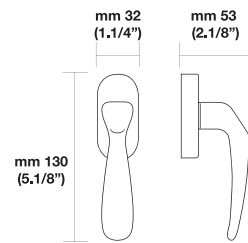



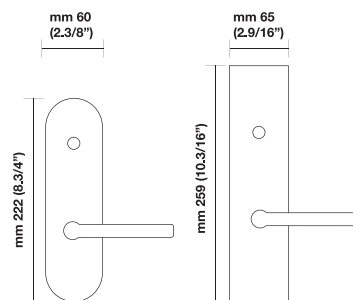

## Escutcheon options/Opzioni EP ER



Conversions from metric to U.S. measurements are approximate.  
<sup>†</sup>Call for pricing.

## Retail Price

Finish			PGE	PCY	DMY R/L Single	ML-F ENTRY
06A	RP		\$ 286.00	\$ 314.00	\$ 136.00	\$ 820.00
14	RP		\$ 314.00	\$ 340.00	\$ 152.00	\$ 820.00
15	RP		\$ 301.00	\$ 324.00	\$ 144.00	\$ 820.00
26D	RP		\$ 273.00	\$ 298.00	\$ 131.00	\$ 820.00

Finish			PGE	PCY	DMY R/L Single	DMY R/L Pair	ML-F ENTRY
15	EP		\$ 471.00	\$ 492.00	\$ 228.00	\$ 413.00	\$ 725.00
		ER	\$ 503.00	\$ 507.00	\$ 245.00	\$ 447.00	\$ 760.00
26D	EP		\$ 471.00	\$ 492.00	\$ 228.00	\$ 413.00	\$ 725.00
		ER	\$ 503.00	\$ 507.00	\$ 245.00	\$ 447.00	\$ 760.00

# H 1017 Serie Camelia

design Matteo Thun

Material Brass/Materiale Ottone



ASSA ABLOY

## Matching elements/Coordinato

- Pg 135** Mortise lock functions
- Pg 144** Deadbolts/Privacy Bolts
- Pg 149** Escutcheons with deadbolts
- Pg 153** Multi-Point Trim functions



## Sizes/Misure

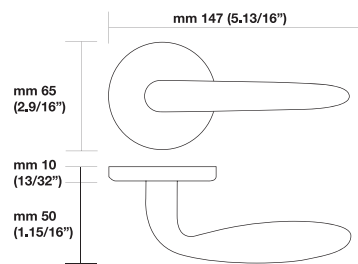

## Window handle/Maniglia per finestra H 1017 F RS<sup>1</sup>

Movement 4 click positions

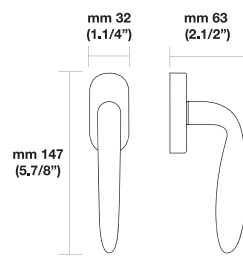



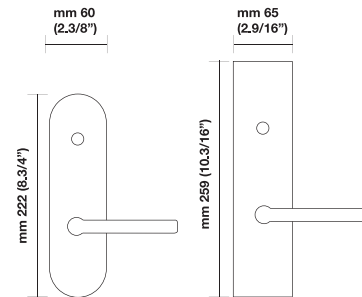



## Escutcheon options/Opzioni EP ER



Conversions from metric to U.S. measurements are approximate.

<sup>1</sup>Call for pricing.

## Retail Price

Finish			PGE	PCY	DMY R/L Single	ML-F ENTRY	
	26D	RP	\$ 236.00	\$ 255.00	\$ 110.00	\$ 759.00	
Finish			PGE	PCY	DMY R/L Single	DMY R/L Pair	ML-F ENTRY
	26D	EP	\$ 412.00	\$ 430.00	\$ 199.00	\$ 354.00	\$ 670.00
		ER	\$ 453.00	\$ 457.00	\$ 218.00	\$ 393.00	\$ 699.00



# H 1018 Serie Otello

design Marius Schreyer Design

Material Brass/Materiale Ottone

## Matching elements/Coordinato

- Pg 135** Mortise lock functions
- Pg 144** Deadbolts/Privacy Bolts
- Pg 149** Escutcheons with deadbolts
- Pg 153** Multi-Point Trim functions



## Sizes/Misure

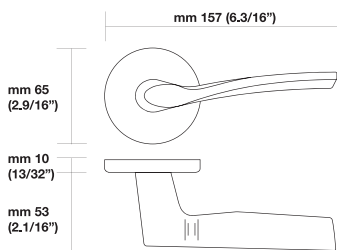

## Window handle/Maniglia per finestra H 1018 F RS<sup>1</sup>

Movement 4 click positions

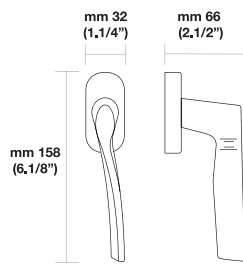



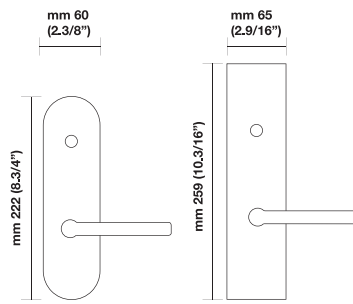

## Escutcheon options/Opzioni EP ER



Conversions from metric to U.S. measurements are approximate.  
<sup>1</sup>Call for pricing.

## Retail Price

Finish			PGE	PCY	DMY R/L Single	DMY R/L Pair	ML-F ENTRY
26/26D	RP		\$ 298.00	\$ 315.00	\$ 140.00		\$ 820.00
Finish			PGE	PCY	DMY R/L Single	DMY R/L Pair	ML-F ENTRY
26/26D	EP		\$ 471.00	\$ 492.00	\$ 228.00	\$ 413.00	\$ 725.00
		ER	\$ 503.00	\$ 507.00	\$ 245.00	\$ 447.00	\$ 760.00

# H 1022 Serie Ernani

design Valli Workshop



ASSA ABLOY

Material Brass/Materiale Ottone

## Matching elements/Coordinato

- Pg 135** Mortise lock functions
- Pg 144** Deadbolts/Privacy Bolts
- Pg 149** Escutcheons with deadbolts
- Pg 153** Multi-Point Trim functions



## Sizes/Misure

**Window handle/Maniglia per finestra  
H 1022 F RS<sup>1</sup>**  
Movement 4 click positions

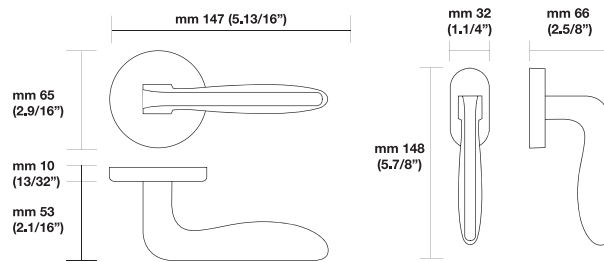



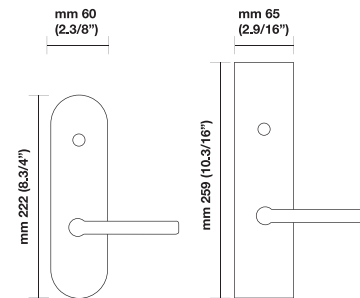





**Escutcheon options/Opzioni  
EP ER**



Conversions from metric to U.S. measurements are approximate.  
<sup>1</sup>Call for pricing.

## Retail Price

Finish			PGE	PCY	DMY R/L Single	DMY R/L Pair	ML-F ENTRY
	03/03D	RP	\$ 298.00	\$ 316.00	\$ 140.00		\$ 759.00
	26D/26	RP	\$ 289.00	\$ 301.00	\$ 134.00		\$ 759.00
Finish			PGE	PCY	DMY R/L Single	DMY R/L Pair	ML-F ENTRY
	03/03D	EP	\$ 452.00	\$ 473.00	\$ 221.00	\$ 401.00	\$ 670.00
	26D/26	EP	\$ 448.00	\$ 464.00	\$ 216.00	\$ 390.00	\$ 670.00
		ER	\$ 453.00	\$ 457.00	\$ 218.00	\$ 393.00	\$ 699.00

# H 1024 Serie Lolita

design Valli Workshop

Material Brass/Materiale Ottone

## Matching elements/Coordinato

- Pg 135** Mortise lock functions
- Pg 144** Deadbolts/Privacy Bolts
- Pg 149** Escutcheons with deadbolts
- Pg 153** Multi-Point Trim functions



## Sizes/Misure

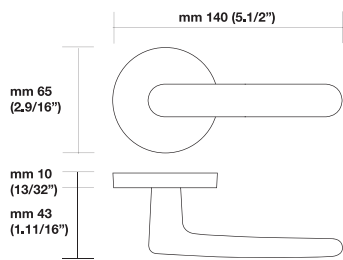

## Window handle/Maniglia per finestra H 1024 F RS<sup>1</sup> Movement 4 click positions

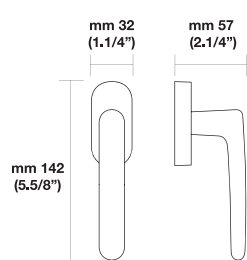



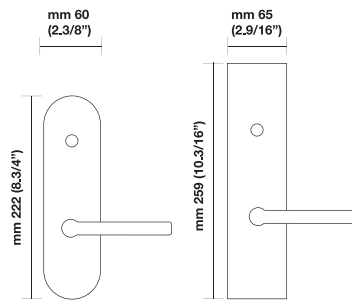







## Escutcheon options/Opzioni EP ER



Conversions from metric to U.S. measurements are approximate.  
<sup>1</sup>Call for pricing.

## Retail Price

Finish			PGE	PCY	DMY R/L Single	ML-F ENTRY
	03	RP	\$ 216.00	\$ 237.00	\$ 99.00	\$ 759.00
	26	RP	\$ 211.00	\$ 224.00	\$ 95.00	\$ 759.00
	26D	RP	\$ 222.00	\$ 235.00	\$ 101.00	\$ 759.00

Finish			PGE	PCY	DMY R/L Single	DMY R/L Pair	ML-F ENTRY
	03	EP	\$ 383.00	\$ 402.00	\$ 183.00	\$ 324.00	\$ 670.00
	26	EP	\$ 379.00	\$ 398.00	\$ 180.00	\$ 321.00	\$ 670.00
		ER	\$ 453.00	\$ 457.00	\$ 218.00	\$ 393.00	\$ 699.00
	26D	EP	\$ 412.00	\$ 430.00	\$ 199.00	\$ 354.00	\$ 670.00
		ER	\$ 453.00	\$ 457.00	\$ 218.00	\$ 393.00	\$ 699.00

# H 1026 Serie Dido

design Antonio Bullo

Material Brass/Materiale Ottone



ASSA ABLOY

## Matching elements/Coordinato

- Pg 135** Mortise lock functions
- Pg 144** Deadbolts/Privacy Bolts
- Pg 149** Escutcheons with deadbolts
- Pg 153** Multi-Point Trim functions



## Sizes/Misure

**Window handle/Maniglia per finestra**  
**H 1026 F RS<sup>1</sup>**  
 Movement 4 click positions

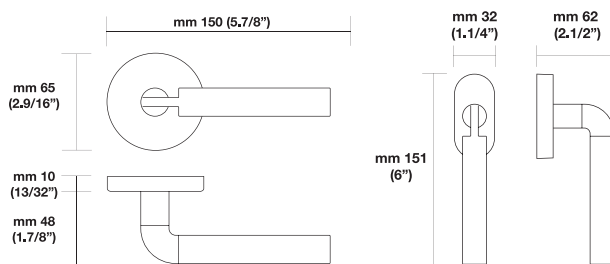



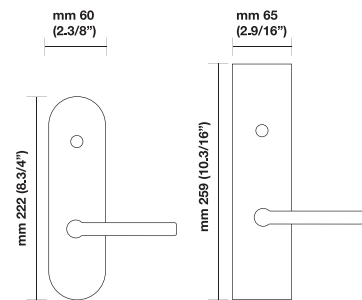

## Escutcheon options/Opzioni







Conversions from metric to U.S. measurements are approximate.  
<sup>1</sup>Call for pricing.

## Retail Price

Finish	 	PGE	PCY	DMY R/L Single	ML-F ENTRY	
	03D/03	<b>RP</b>	\$ 285.00	\$ 314.00	\$ 137.00	\$ 820.00
	26D/26	<b>RP</b>	\$ 290.00	\$ 316.00	\$ 138.00	\$ 820.00

Finish	 	PGE	PCY	DMY R/L Single	DMY R/L Pair	ML-F ENTRY	
	03D/03	<b>EP</b>	\$ 471.00	\$ 492.00	\$ 228.00	\$ 413.00	\$ 725.00
	26D/26	<b>EP</b>	\$ 471.00	\$ 492.00	\$ 228.00	\$ 413.00	\$ 725.00
		<b>ER</b>	\$ 503.00	\$ 507.00	\$ 245.00	\$ 447.00	\$ 760.00

# H 1027 Serie Dafne

design Studio Carlesi Design

Material Brass/Materiale Ottone

## Matching elements/Coordinato

- Pg 135** Mortise lock functions
- Pg 144** Deadbolts/Privacy Bolts
- Pg 149** Escutcheons with deadbolts
- Pg 153** Multi-Point Trim functions



## Sizes/Misure

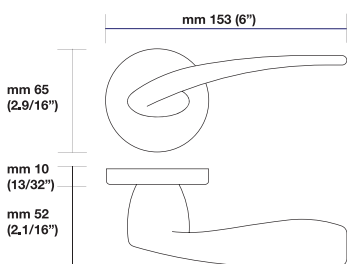

## Window handle/Maniglia per finestra H 1027 F RS<sup>1</sup>

Movement 4 click positions

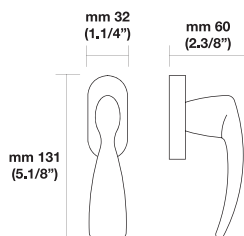



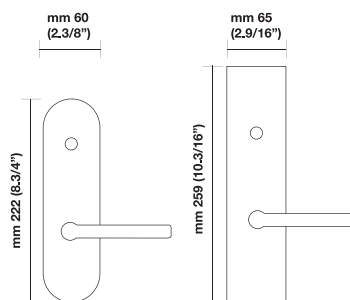

## Escutcheon options/Opzioni EP ER







Conversions from metric to U.S. measurements are approximate.

<sup>1</sup>Call for pricing.

## Retail Price

Finish			PGE	PCY /bolt	DMY R/L Single	ML-F ENTRY
 03	<b>RP</b>		\$ 280.00	\$ 514.00*	\$ 131.00	\$ 820.00
 26D	<b>RP</b>		\$ 287.00	\$ 555.00*	\$ 133.00	\$ 820.00

\* Supplied with 105 RSP Privacy Bolt

Finish			PGE	PCY /bolt	DMY R/L Single	DMY R/L Pair	ML-F ENTRY
 03	<b>EP</b>		\$ 443.00	\$ 536.00*	\$ 218.00	\$ 393.00	\$ 725.00
 26D	<b>EP</b>		\$ 438.00	\$ 546.00*	\$ 218.00	\$ 381.00	\$ 725.00
	<b>ER</b>		\$ 503.00	\$ 607.00*	\$ 245.00	\$ 447.00	\$ 760.00

\* Supplied with 105 RSP Privacy Bolt

# H 1034 Serie Polis

design Decoma Design



ASSA ABLOY

Material Nikrall Zamak alloy UNI 3717/Materiale Lega Zama UNI 3717

## Matching elements/Coordinato

- Pg 135** Mortise lock functions
- Pg 144** Deadbolts/Privacy Bolts
- Pg 149** Escutcheons with deadbolts
- Pg 153** Multi-Point Trim functions



## Sizes/Misure



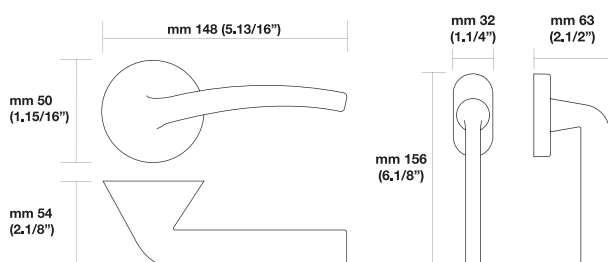

### Window handle/Maniglia per finestra H 1034 F RS<sup>1</sup>

Movement 4 click positions



Conversions from metric to U.S. measurements are approximate.  
<sup>1</sup>Call for pricing.

## Retail Price

Finish			PGE	PCY /bolt	DMY R/L Single	ML-F ENTRY
			\$ 216.00	\$ 422.00*	\$ 111.00	\$ 759.00
			\$ 229.00	\$ 458.00*	\$ 115.00	\$ 759.00

\* Supplied with 105 RSP Privacy Bolt

**NOTE:** Not available with long escutcheon. Not recommended for commercial use.

# H 1037 Serie Teseo

design Valli Workshop

Material Brass/Materiale Ottone

## Matching elements/Coordinato

- Pg 135** Mortise lock functions
- Pg 144** Deadbolts/Privacy Bolts
- Pg 149** Escutcheons with deadbolts
- Pg 153** Multi-Point Trim functions



## Sizes/Misure

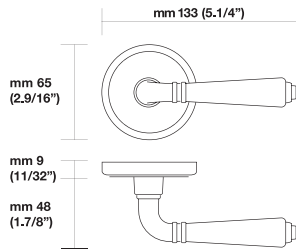

## Window handle/Maniglia per finestra H 1037 F RS<sup>1</sup>

Movement 4 click positions

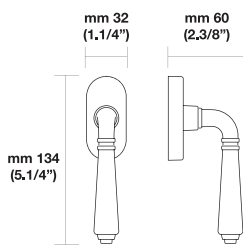



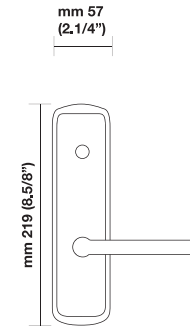

## Escutcheon options/Opzioni ET





Conversions from metric to U.S. measurements are approximate.  
<sup>1</sup>Call for pricing.

## Retail Price

Finish			PGE	PCY	DMY R/L Single	ML-F ENTRY
	03	<b>RT</b>	\$ 201.00	\$ 221.00	\$ 93.00	\$ 759.00
	14	<b>RT</b>	\$ 258.00	\$ 286.00	\$ 124.00	\$ 759.00
	15	<b>RT</b>	\$ 241.00	\$ 270.00	\$ 113.00	\$ 759.00

Finish			PGE	PCY	DMY R/L Single	DMY R/L Pair	ML-F ENTRY
	03	<b>ET</b>	\$ 412.00	\$ 430.00	\$ 199.00	\$ 354.00	\$ 670.00

# H 1038 Serie Armida

design Decoma Design



ASSA ABLOY

Material Nikrall Zamak alloy UNI 3717/Materiale Lega Zama UNI 3717

## Matching elements/Coordinato

- Pg 135** Mortise lock functions
- Pg 144** Deadbolts/Privacy Bolts
- Pg 149** Escutcheons with deadbolts
- Pg 153** Multi-Point Trim functions

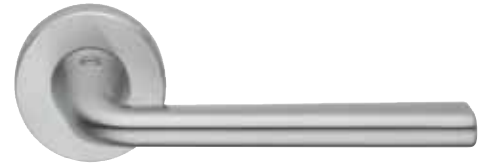

## Sizes/Misure

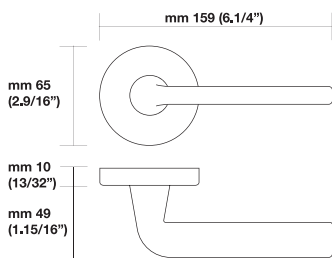

## Window handle/Maniglia per finestra H 1038 F RS<sup>1</sup>

Movement 4 click positions

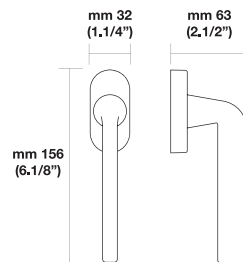



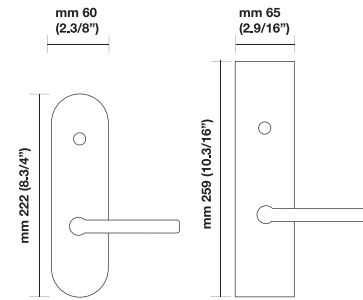



## Escutcheon options/Opzioni EP ER









Conversions from metric to U.S. measurements are approximate.

<sup>1</sup>Call for pricing.

## Retail Price

Finish			PGE	PCY	DMY R/L Single	ML-F ENTRY
	14	<b>RP</b>	\$ 291.00	\$ 305.00	\$ 136.00	\$ 759.00
	15	<b>RP</b>	\$ 282.00	\$ 294.00	\$ 131.00	\$ 759.00
	17/03D	<b>RP</b>	\$ 260.00	\$ 280.00	\$ 122.00	\$ 759.00
	26D	<b>RP</b>	\$ 256.00	\$ 268.00	\$ 118.00	\$ 759.00
	26/26D	<b>RP</b>	\$ 260.00	\$ 280.00	\$ 122.00	\$ 759.00

Finish			PGE	PCY	DMY R/L Single	DMY R/L Pair	ML-F ENTRY
	15	<b>EP</b>	\$ 412.00	\$ 430.00	\$ 199.00	\$ 354.00	\$ 670.00
		<b>ER</b>	\$ 453.00	\$ 457.00	\$ 218.00	\$ 393.00	\$ 699.00
	17/03D	<b>EP</b>	\$ 412.00	\$ 430.00	\$ 199.00	\$ 354.00	\$ 670.00
	26D	<b>EP</b>	\$ 412.00	\$ 430.00	\$ 199.00	\$ 354.00	\$ 670.00
		<b>ER</b>	\$ 453.00	\$ 457.00	\$ 218.00	\$ 393.00	\$ 699.00
	26/26D	<b>EP</b>	\$ 412.00	\$ 430.00	\$ 199.00	\$ 354.00	\$ 670.00
		<b>ER</b>	\$ 453.00	\$ 457.00	\$ 218.00	\$ 393.00	\$ 699.00



# H 1039 Serie Fedra

design Jean-Baptiste Sibertin Blanc

Material Brass/Materiale Ottone

## Matching elements/Coordinato

- Pg 135** Mortise lock functions
- Pg 144** Deadbolts/Privacy Bolts
- Pg 149** Escutcheons with deadbolts
- Pg 153** Multi-Point Trim functions



## Sizes/Misure

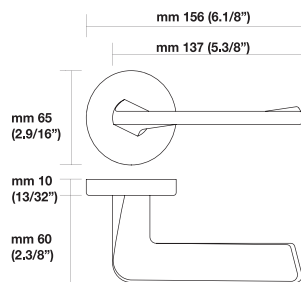

## Window handle/Maniglia per finestra H 1039 F RS<sup>1</sup>

Movement 4 click positions

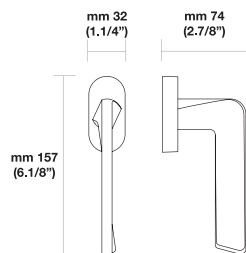



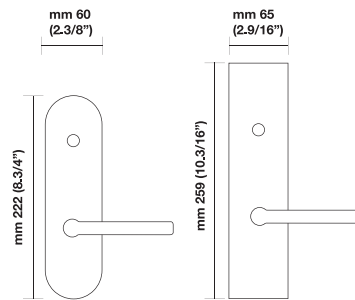



## Escutcheon options/Opzioni EP ER



Conversions from metric to U.S. measurements are approximate.  
<sup>1</sup>Call for pricing.

## Retail Price

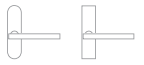
Finish		PGE	PCY	DMY R/L Single	ML-F ENTRY
 14	<b>RP</b>	\$ 288.00	\$ 318.00	\$ 138.00	\$ 956.00
 15	<b>RP</b>	\$ 288.00	\$ 318.00	\$ 138.00	\$ 956.00
 26/26D	<b>RP</b>	\$ 255.00	\$ 283.00	\$ 122.00	\$ 956.00

Finish		PGE	PCY	DMY R/L Single	DMY R/L Pair	ML-F ENTRY
 15	<b>EP</b>	\$ 618.00	\$ 637.00	\$ 302.00	\$ 560.00	\$ 860.00
	<b>ER</b>	\$ 660.00	\$ 664.00	\$ 321.00	\$ 599.00	\$ 890.00
 26/26D	<b>EP</b>	\$ 618.00	\$ 637.00	\$ 302.00	\$ 560.00	\$ 860.00
	<b>ER</b>	\$ 660.00	\$ 664.00	\$ 321.00	\$ 599.00	\$ 890.00

# H 1042 Serie Walkiria

design Panacom Architects/Arseniy Leonovich



ASSA ABLOY

Material Brass/Materiale Ottone

## Matching elements/Coordinato

- Pg 135** Mortise lock functions
- Pg 144** Deadbolts/Privacy Bolts
- Pg 149** Escutcheons with deadbolts
- Pg 153** Multi-Point Trim functions



## Sizes/Misure

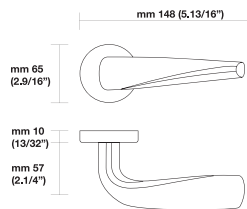

## Window handle/Maniglia per finestra H 1042 F RS<sup>1</sup>

Movement 4 click positions

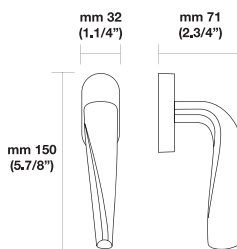

## Escutcheon options/Opzioni EP ER

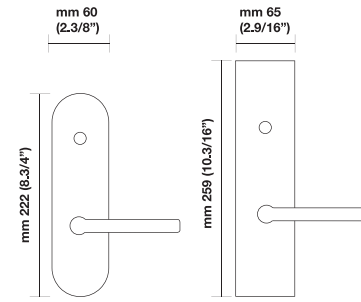

Conversions from metric to U.S. measurements are approximate.

<sup>1</sup>Call for pricing.

## Retail Price

Finish		PGE	PCY	DMY R/L Single	ML-F ENTRY	
	14	RP	\$ 514.00	\$ 536.00	\$ 249.00	\$ 956.00
	15	RP	\$ 514.00	\$ 536.00	\$ 249.00	\$ 956.00
	26	RP	\$ 461.00	\$ 469.00	\$ 221.00	\$ 956.00
	26D	RP	\$ 432.00	\$ 443.00	\$ 205.00	\$ 956.00

Finish		PGE	PCY	DMY R/L Single	DMY R/L Pair	ML-F ENTRY	
	15	EP	\$ 618.00	\$ 637.00	\$ 302.00	\$ 560.00	\$ 860.00
		ER	\$ 660.00	\$ 664.00	\$ 321.00	\$ 599.00	\$ 890.00
	26	EP	\$ 618.00	\$ 637.00	\$ 302.00	\$ 560.00	\$ 860.00
		ER	\$ 660.00	\$ 664.00	\$ 321.00	\$ 599.00	\$ 890.00
	26D	EP	\$ 618.00	\$ 637.00	\$ 302.00	\$ 560.00	\$ 860.00
		ER	\$ 660.00	\$ 664.00	\$ 321.00	\$ 599.00	\$ 890.00

# H 1043 Serie Alcina

design Matteo Thun

Material nikrall zamak alloy UNI 3717/Materiale Lega Zama UNI 3717

## Matching elements/Coordinato

- Pg 135** Mortise lock functions
- Pg 144** Deadbolts/Privacy Bolts
- Pg 149** Escutcheons with deadbolts
- Pg 153** Multi-Point Trim functions

## Rosette options/Opzioni

**RQ**  
mm 65  
(2.9/16")

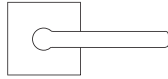

## Sizes/Misure

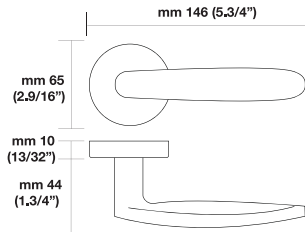

## Window handle/Maniglia per finestra

**H 1043 F RS<sup>†</sup>**

Movement 4 click positions

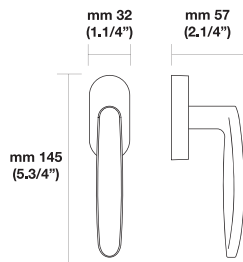

## Escutcheon options/Opzioni



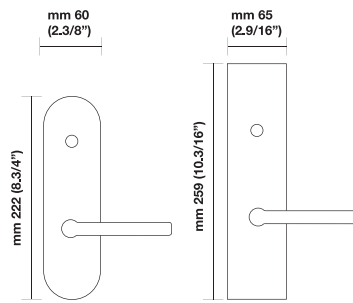

**EP ER**



Conversions from metric to U.S. measurements are approximate.

<sup>†</sup>Call for pricing.

## Retail Price

Finish	 	PGE	PCY	DMY R/L Single	DMY R/L Pair	ML-F ENTRY
15	<b>RP</b>	\$ 196.00	\$ 199.00	\$ 99.00		\$ 734.00
	<b>RQ</b>	\$ 299.00	\$ 320.00	\$ 160.00		\$ 798.00
26/26D	<b>RP</b>	\$ 176.00	\$ 195.00	\$ 88.00		\$ 734.00
	<b>RQ</b>	\$ 269.00	\$ 290.00	\$ 140.00		\$ 798.00
Finish	 	PGE	PCY	DMY R/L Single	DMY R/L Pair	ML-F ENTRY
15	<b>EP</b>	\$ 360.00	\$ 393.00	\$ 197.00	\$ 335.00	\$ 640.00
	<b>ER</b>	\$ 431.00	\$ 442.00	\$ 207.00	\$ 371.00	\$ 670.00
26/26D	<b>EP</b>	\$ 360.00	\$ 393.00	\$ 197.00	\$ 335.00	\$ 640.00
	<b>ER</b>	\$ 431.00	\$ 442.00	\$ 207.00	\$ 371.00	\$ 670.00

# H 1044 Serie Oberon

design Vincent Van Duysen



ASSA ABLOY

Material nikral zamak alloy UNI 3717/Materiale Lega Zama UNI 3717

## Matching elements/Coordinato

- Pg 135** Mortise lock functions
- Pg 144** Deadbolts/Privacy Bolts
- Pg 149** Escutcheons with deadbolts
- Pg 153** Multi-Point Trim functions

## Rosette options/Opzioni RQ

mm 65  
(2.9/16")

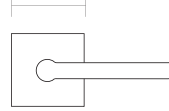

## Sizes/Misure

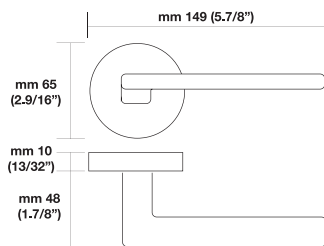

## Window handle/Maniglia per finestra H 1044 F RS<sup>1</sup>

Movement 4 click positions

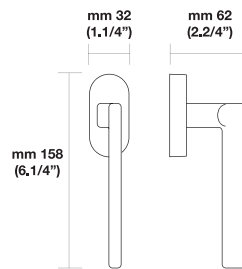



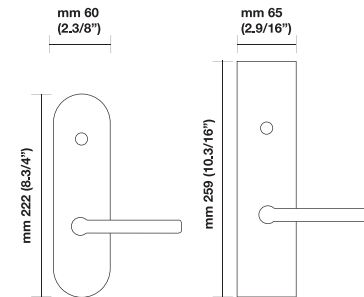







## Escutcheon options/Opzioni EP ER



Conversions from metric to U.S. measurements are approximate.

<sup>1</sup>Call for pricing.

## Retail Price

Finish			PGE	PCY	DMY R/L Single	ML-F ENTRY	
	14	RP	\$ 196.00	\$ 199.00	\$ 99.00	\$ 734.00	
		RQ	\$ 297.00	\$ 299.00	\$ 165.00	\$ 798.00	
	15	RP	\$ 196.00	\$ 199.00	\$ 99.00	\$ 734.00	
		RQ	\$ 297.00	\$ 299.00	\$ 165.00	\$ 798.00	
	26	RP	\$ 176.00	\$ 195.00	\$ 88.00	\$ 734.00	
		RQ	\$ 273.00	\$ 293.00	\$ 140.00	\$ 798.00	
	26D	RP	\$ 180.00	\$ 197.00	\$ 90.00	\$ 734.00	
		RQ	\$ 280.00	\$ 299.00	\$ 155.00	\$ 798.00	
Finish			PGE	PCY	DMY R/L Single	DMY R/L Pair	ML-F ENTRY
	15	EP	\$ 360.00	\$ 393.00	\$ 197.00	\$ 335.00	\$ 640.00
		ER	\$ 431.00	\$ 442.00	\$ 207.00	\$ 371.00	\$ 670.00
	26	EP	\$ 360.00	\$ 393.00	\$ 197.00	\$ 335.00	\$ 640.00
		ER	\$ 431.00	\$ 442.00	\$ 207.00	\$ 371.00	\$ 670.00
	26D	EP	\$ 360.00	\$ 393.00	\$ 197.00	\$ 335.00	\$ 640.00
		ER	\$ 431.00	\$ 442.00	\$ 207.00	\$ 371.00	\$ 670.00

# H 1045 Serie Bess

design Yoshimi Kono

Material ZINC Alloy

## Matching elements/Coordinato

- Pg 76** Door pulls
- Pg 87** Pocket doors
- Pg 135** Mortise lock functions
- Pg 144** Deadbolts/Privacy Bolts
- Pg 149** Escutcheons with deadbolts
- Pg 153** Multi-Point Trim functions

## Rosette options/Opzioni RP

mm 65  
(2.9/16")

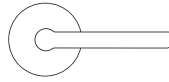

## Sizes/Misure

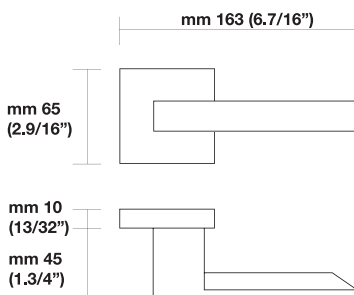

## Window handle/Maniglia per finestra H 1045 F RS<sup>1</sup>

Movement 4 click positions

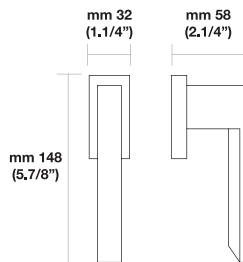



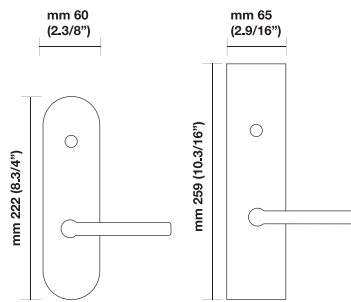

## Escutcheon options/Opzioni EP ER



Conversions from metric to U.S. measurements are approximate.  
<sup>1</sup>Call for pricing.

## Retail Price

Finish				PGE	PCY	DMY R/L Single	ML-F ENTRY
14 <sup>3</sup>	RP			\$ 359.00	\$ 373.00	\$ 170.00	\$ 820.00
	RQ			\$ 470.00	\$ 482.00	\$ 233.00	\$ 880.00
15	RP			\$ 348.00	\$ 363.00	\$ 164.00	\$ 820.00
	RQ			\$ 449.00	\$ 459.00	\$ 226.00	\$ 880.00
26	RP			\$ 321.00	\$ 329.00	\$ 150.00	\$ 820.00
	RQ			\$ 414.00	\$ 428.00	\$ 204.00	\$ 880.00
26D/26	RP			\$ 336.00	\$ 349.00	\$ 159.00	\$ 820.00
	RQ			\$ 438.00	\$ 451.00	\$ 221.00	\$ 880.00

Finish				PGE	PCY	DMY R/L Single	DMY R/L Pair	ML-F ENTRY
15	EP			\$ 471.00	\$ 492.00	\$ 228.00	\$ 413.00	\$ 725.00
	ER			\$ 503.00	\$ 507.00	\$ 245.00	\$ 447.00	\$ 760.00
26	EP			\$ 471.00	\$ 492.00	\$ 228.00	\$ 413.00	\$ 725.00
	ER			\$ 503.00	\$ 507.00	\$ 245.00	\$ 447.00	\$ 760.00
26D/26	EP			\$ 471.00	\$ 492.00	\$ 228.00	\$ 413.00	\$ 725.00
	ER			\$ 503.00	\$ 507.00	\$ 245.00	\$ 447.00	\$ 760.00

# H 1046 Serie Nais

design Valli Workshop

Material Brass/Materiale Ottone

## Matching elements/Coordinato

- Pg 135** Mortise lock functions
- Pg 144** Deadbolts/Privacy Bolts
- Pg 149** Escutcheons with deadbolts
- Pg 153** Multi-Point Trim functions

## Rosette options/Opzioni RP

mm 65  
(2.9/16")

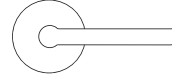

## Sizes/Misure

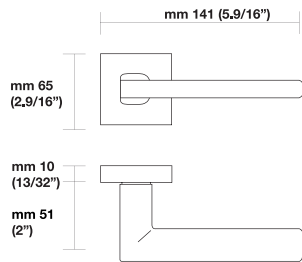

## Window handle/Maniglia per finestra H 1046 F RS<sup>1</sup>

Movement 4 click positions

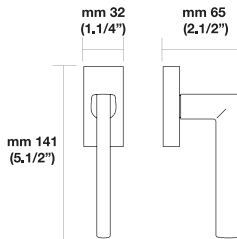



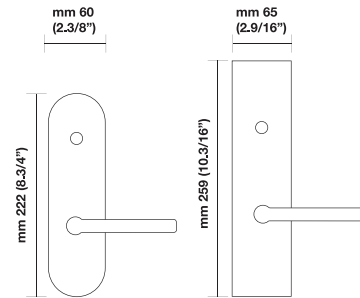







## Escutcheon options/Opzioni EP ER



Conversions from metric to U.S. measurements are approximate.  
<sup>1</sup>Call for pricing.

## Retail Price

Finish			PGE	PCY	DMY R/L Single	ML-F ENTRY
	<b>RP</b>		\$ 282.00	\$ 299.00	\$ 133.00	\$ 820.00
		<b>RQ</b>	\$ 396.00	\$ 406.00	\$ 195.00	\$ 880.00
	<b>RP</b>		\$ 276.00	\$ 290.00	\$ 128.00	\$ 820.00
		<b>RQ</b>	\$ 375.00	\$ 390.00	\$ 190.00	\$ 880.00
	<b>RP</b>		\$ 255.00	\$ 264.00	\$ 116.00	\$ 820.00
		<b>RQ</b>	\$ 346.00	\$ 359.00	\$ 171.00	\$ 880.00
	<b>RP</b>		\$ 260.00	\$ 273.00	\$ 119.00	\$ 820.00
		<b>RQ</b>	\$ 363.00	\$ 376.00	\$ 184.00	\$ 880.00

Finish			PGE	PCY	DMY R/L Single	DMY R/L Pair	ML-F ENTRY
	<b>EP</b>		\$ 471.00	\$ 492.00	\$ 228.00	\$ 413.00	\$ 725.00
		<b>ER</b>	\$ 503.00	\$ 507.00	\$ 245.00	\$ 447.00	\$ 760.00
	<b>EP</b>		\$ 471.00	\$ 492.00	\$ 228.00	\$ 413.00	\$ 725.00
		<b>ER</b>	\$ 503.00	\$ 507.00	\$ 245.00	\$ 447.00	\$ 760.00
	<b>EP</b>		\$ 471.00	\$ 492.00	\$ 228.00	\$ 413.00	\$ 725.00
		<b>ER</b>	\$ 503.00	\$ 507.00	\$ 245.00	\$ 447.00	\$ 760.00

# H 1049 Serie Divara

design Valli Workshop

Material Brass/Materiale Ottone

## Matching elements/Coordinato

- Pg 135** Mortise lock functions
- Pg 144** Deadbolts/Privacy Bolts
- Pg 149** Escutcheons with deadbolts
- Pg 153** Multi-Point Trim functions

## Rosette options/Opzioni RP

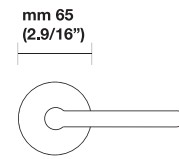

European Version Rosette

## Sizes/Misure

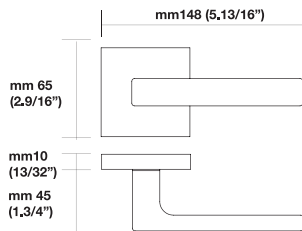

## Window handle/Maniglia per finestra H 1049 F RS<sup>1</sup> Movement 4 click positions

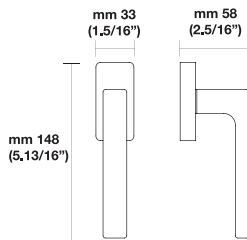

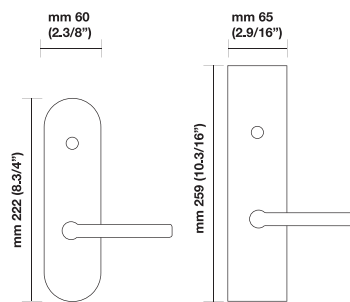

## Escutcheon options/Opzioni EP ER



Conversions from metric to U.S. measurements are approximate.  
<sup>1</sup>Call for pricing.

## Retail Price

Finish		PGE	PCY	DMY R/L Single	ML-F ENTRY
26	RP	\$ 301.00	\$ 324.00	\$ 143.00	\$ 820.00
	RQ	\$ 397.00	\$ 421.00	\$ 198.00	\$ 880.00
26D	RP	\$ 304.00	\$ 329.00	\$ 144.00	\$ 820.00
	RQ	\$ 411.00	\$ 433.00	\$ 208.00	\$ 880.00

Finish		PGE	PCY	DMY R/L Single	DMY R/L Pair	ML-F ENTRY
26	EP	\$ 471.00	\$ 492.00	\$ 228.00	\$ 413.00	\$ 725.00
	ER	\$ 503.00	\$ 507.00	\$ 245.00	\$ 447.00	\$ 760.00
26D	EP	\$ 471.00	\$ 492.00	\$ 228.00	\$ 413.00	\$ 725.00
	ER	\$ 503.00	\$ 507.00	\$ 245.00	\$ 447.00	\$ 760.00

# H 1050 Serie Giasone

design Valli Workshop

Material Brass /Materiale Ottone



ASSA ABLOY

## Matching elements/Coordinato

- Pg 135** Mortise lock functions
- Pg 144** Deadbolts/Privacy Bolts
- Pg 149** Escutcheons with deadbolts
- Pg 153** Multi-Point Trim functions

## Rosette options/Opzioni

**RQ**  
mm 65  
(2.9/16")

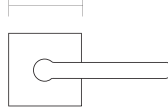

## Sizes/Misure

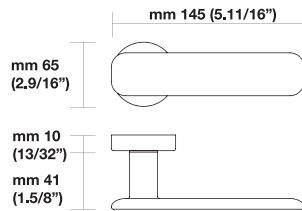

## Window handle/Maniglia per finestra

**H 1050 F RS<sup>1</sup>**

Movement 4 click positions

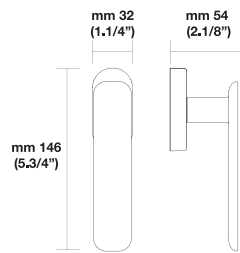

## Escutcheon options/Opzioni

**EP**



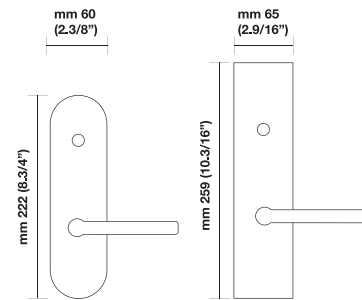

**ER**



Conversions from metric to U.S. measurements are approximate.

<sup>1</sup>Call for pricing.

## Retail Price

Finish	 	PGE	PCY	DMY R/L Single	DMY R/L Pair	ML-F ENTRY
26	<b>RP</b>	\$ 285.00	\$ 310.00	\$ 142.00		\$ 759.00
	<b>RQ</b>	\$ 382.00	\$ 405.00	\$ 199.00		\$ 830.00
26D	<b>RP</b>	\$ 285.00	\$ 310.00	\$ 142.00		\$ 759.00
	<b>RQ</b>	\$ 392.00	\$ 412.00	\$ 209.00		\$ 830.00
Finish	 	PGE	PCY	DMY R/L Single	DMY R/L Pair	ML-F ENTRY
26	<b>EP</b>	\$ 412.00	\$ 430.00	\$ 199.00	\$ 354.00	\$ 670.00
	<b>ER</b>	\$ 453.00	\$ 457.00	\$ 218.00	\$ 393.00	\$ 699.00
26D	<b>EP</b>	\$ 412.00	\$ 430.00	\$ 199.00	\$ 354.00	\$ 670.00
	<b>ER</b>	\$ 453.00	\$ 457.00	\$ 218.00	\$ 393.00	\$ 699.00



# H 1051 Serie Tieste

design Yoshimi Kono

Material Brass/Materiale Ottone

## Matching elements/Coordinato

- Pg 135** Mortise lock functions
- Pg 144** Deadbolts/Privacy Bolts
- Pg 149** Escutcheons with deadbolts
- Pg 153** Multi-Point Trim functions

## Rosette options/Opzioni RQ

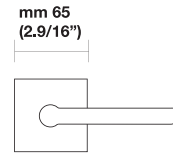

## Sizes/Misure

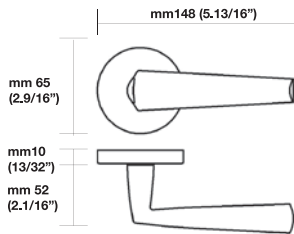

## Window handle/Maniglia per finestra H 1051 F RS<sup>†</sup> Movement 4 click positions

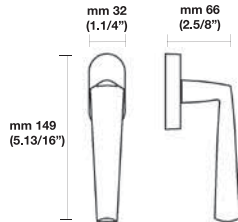



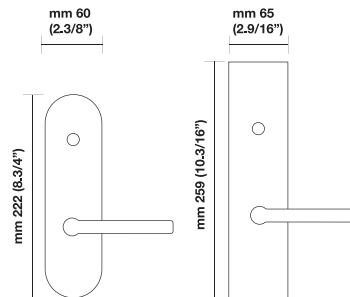

## Escutcheon options/Opzioni EP ER



Conversions from metric to U.S. measurements are approximate.  
<sup>†</sup>Call for pricing.

## Retail Price

Finish	 	PGE	PCY	DMY R/L Single	ML-F ENTRY
26	<b>RP</b>	\$ 322.00	\$ 342.00	\$ 160.00	\$ 820.00
	<b>RQ</b>	\$ 419.00	\$ 443.00	\$ 217.00	\$ 880.00
26D	<b>RP</b>	\$ 340.00	\$ 365.00	\$ 170.00	\$ 820.00
	<b>RQ</b>	\$ 447.00	\$ 472.00	\$ 238.00	\$ 880.00

Finish	 	PGE	PCY	DMY R/L Single	DMY R/L Pair	ML-F ENTRY
26	<b>EP</b>	\$ 471.00	\$ 492.00	\$ 228.00	\$ 413.00	\$ 725.00
	<b>ER</b>	\$ 503.00	\$ 507.00	\$ 245.00	\$ 447.00	\$ 760.00
26D	<b>EP</b>	\$ 471.00	\$ 492.00	\$ 228.00	\$ 413.00	\$ 725.00
	<b>ER</b>	\$ 503.00	\$ 507.00	\$ 245.00	\$ 447.00	\$ 760.00

# H 4705 Serie Rhodamine

design Valli Workshop



ASSA ABLOY

Material Nikrall Zamak alloy UNI 3717 and Stainless steel AISI 304/Materiale Nikrall Lega Zama UNI 3717 e Acciaio Inox AISI 304

## Matching elements/Coordinato

- Pg 135** Mortise lock functions
- Pg 144** Deadbolts/Privacy Bolts
- Pg 149** Escutcheons with deadbolts
- Pg 153** Multi-Point Trim functions



## Sizes/Misure

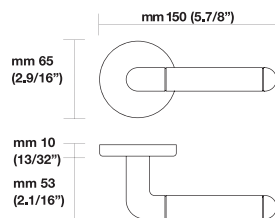

## Window handle/Maniglia per finestra H 4705 F RS<sup>1</sup>

Movement 4 click positions

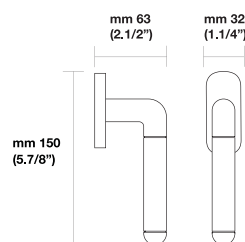

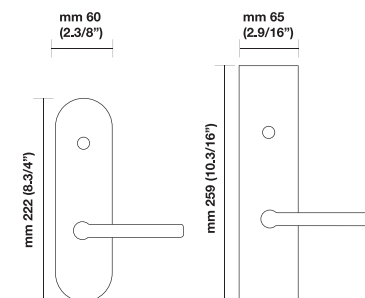

## Escutcheon options/Opzioni EP ER





Conversions from metric to U.S. measurements are approximate.  
<sup>1</sup>Call for pricing.

## Retail Price

Finish			PGE	PCY	DMY R/L Single	ML-F ENTRY
26/32D	<b>RP</b>		\$ 178.00	\$ 198.00	\$ 90.00	\$ 734.00

Finish			PGE	PCY	DMY R/L Single	DMY R/L Pair	ML-F ENTRY
26/32D	<b>EP</b>		\$ 360.00	\$ 393.00	\$ 197.00	\$ 335.00	\$ 640.00
		<b>ER</b>	\$ 431.00	\$ 442.00	\$ 207.00	\$ 371.00	\$ 670.00

# H 4707 Serie Grey

design Valli Workshop

Material Nikrall Zamak alloy UNI 3717/Materiale Nikrall Lega Zama UNI 3717

## Matching elements/Coordinato

- Pg 135** Mortise lock functions
- Pg 144** Deadbolts/Privacy Bolts
- Pg 149** Escutcheons with deadbolts
- Pg 153** Multi-Point Trim functions



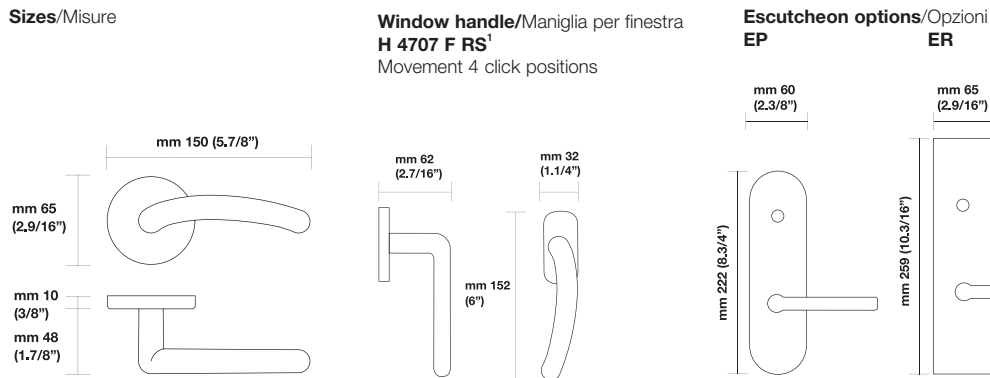

## Sizes/Misure





Conversions from metric to U.S. measurements are approximate.  
<sup>1</sup>Call for pricing.

## Retail Price

Finish			PGE	PCY	DMY R/L Single	ML-F ENTRY
26D	<b>RP</b>		\$ 140.00	\$ 162.00	\$ 72.00	\$ 734.00

Finish			PGE	PCY	DMY R/L Single	DMY R/L Pair	ML-F ENTRY
26D	<b>EP</b>		\$ 360.00	\$ 393.00	\$ 197.00	\$ 335.00	\$ 640.00
		<b>ER</b>	\$ 431.00	\$ 442.00	\$ 207.00	\$ 371.00	\$ 670.00

# H 4730 Serie White

design Valli Workshop



ASSA ABLOY

Material Nikrall Zamak alloy UNI 3717/Materiale Nikrall Lega Zama UNI 3717

## Matching elements/Coordinato

- Pg 135** Mortise lock functions
- Pg 144** Deadbolts/Privacy Bolts
- Pg 149** Escutcheons with deadbolts
- Pg 153** Multi-Point Trim functions



## Sizes/Misure

### Window handle/Maniglia per finestra H 4730 F RS<sup>1</sup> Movement 4 click positions

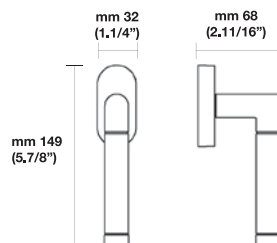
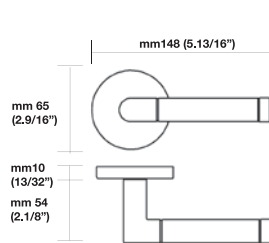



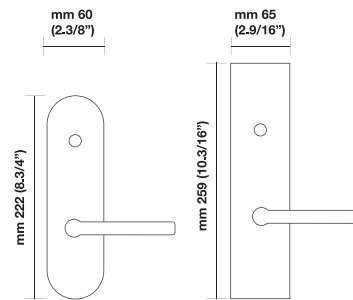



### Escutcheon options/Opzioni EP ER



Conversions from metric to U.S. measurements are approximate.  
<sup>1</sup>Call for pricing.

## Retail Price

Finish			PGE	PCY	DMY R/L Single	ML-F ENTRY	
	26/26D	RP	\$ 196.00	\$ 199.00	\$ 99.00	\$ 734.00	
Finish			PGE	PCY	DMY R/L Single	DMY R/L Pair	ML-F ENTRY
	26/26D	EP	\$ 360.00	\$ 393.00	\$ 197.00	\$ 335.00	\$ 640.00
		ER	\$ 431.00	\$ 442.00	\$ 207.00	\$ 371.00	\$ 670.00

# H 4734 Serie Magenta

design Valli Workshop

Material Nikrall Brass and Stainless steel AISI 304/Materiale Nikrall Ottone e Acciaio Inox AISI 304

## Matching elements/Coordinato

- Pg 135** Mortise lock functions
- Pg 144** Deadbolts/Privacy Bolts
- Pg 149** Escutcheons with deadbolts
- Pg 153** Multi-Point Trim functions



## Sizes/Misure

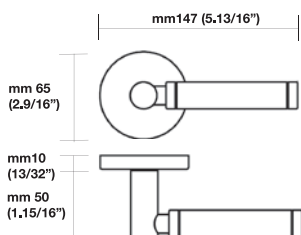

## Window handle/Maniglia per finestra H 4734 F RS<sup>1</sup>

Movement 4 click positions

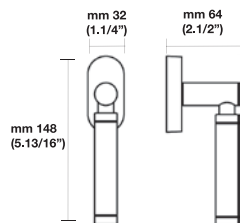



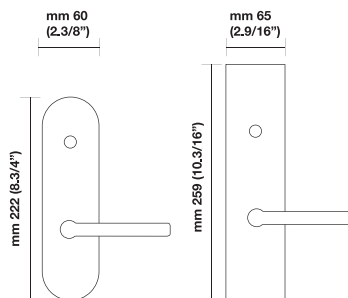

## Escutcheon options/Opzioni EP ER



Conversions from metric to U.S. measurements are approximate.

<sup>1</sup>Call for pricing.

## Retail Price

Finish			PGE	PCY	DMY R/L Single	DMY R/L Pair	ML - F ENTRY
26/32D	<b>RP</b>		\$ 196.00	\$ 199.00	\$ 99.00		\$ 734.00
Finish			PGE	PCY	DMY R/L Single	DMY R/L Pair	ML - F ENTRY
26/32D	<b>EP</b>		\$ 360.00	\$ 393.00	\$ 197.00	\$ 335.00	\$ 640.00
		<b>ER</b>	\$ 431.00	\$ 442.00	\$ 207.00	\$ 371.00	\$ 670.00

# H 4742 Serie Coral

design Valli Workshop



ASSA ABLOY

Material Nikrall Zamak alloy UNI 3717 and Stainless steel AISI 304/Materiale Nikrall Lega Zama UNI 3717 e Acciaio Inox AISI 304

## Matching elements/Coordinato

- Pg 135** Mortise lock functions
- Pg 144** Deadbolts/Privacy Bolts
- Pg 149** Escutcheons with deadbolts
- Pg 153** Multi-Point Trim functions



## Sizes/Misure

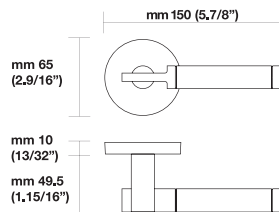

## Window handle/Maniglia per finestra H 4742 F RS<sup>1</sup>

Movement 4 click positions

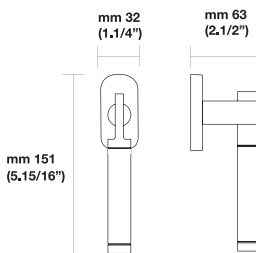

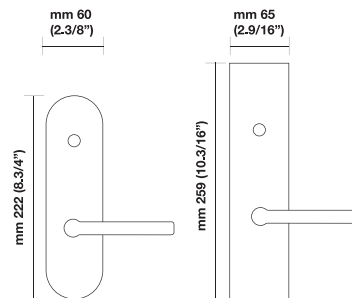

## Escutcheon options/Opzioni EP ER





Conversions from metric to U.S. measurements are approximate.  
<sup>1</sup>Call for pricing.

## Retail Price

Finish			PGE	PCY	DMY R/L Single	ML-F ENTRY
26/32D	<b>RP</b>		\$ 176.00	\$ 195.00	\$ 88.00	\$ 734.00

Finish			PGE	PCY	DMY R/L Single	DMY R/L Pair	ML -F ENTRY
26/32D	<b>EP</b>		\$ 360.00	\$ 393.00	\$ 197.00	\$ 335.00	\$ 640.00
		<b>ER</b>	\$ 431.00	\$ 442.00	\$ 207.00	\$ 371.00	\$ 670.00

# H 4744 Serie Artica

design Valli Workshop

Material Nikrall Brass and Stainless Steel AISI 304/Materiale Nikrall Ottone e Acciaio Inox AISI 304

## Matching elements/Coordinato

- Pg 135** Mortise lock functions
- Pg 144** Deadbolts/Privacy Bolts
- Pg 149** Escutcheons with deadbolts
- Pg 153** Multi-Point Trim functions



## Sizes/Misure

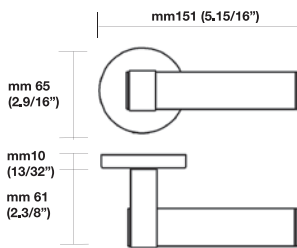

## Window handle/Maniglia per finestra H 4744 F RS<sup>1</sup>

Movement 4 click positions

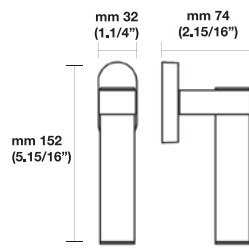



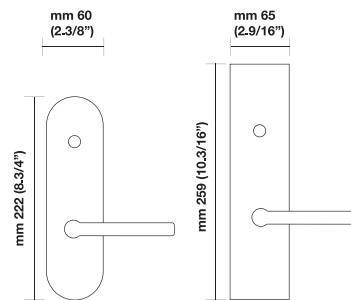

## Escutcheon options/Opzioni EP ER



Conversions from metric to U.S. measurements are approximate.  
<sup>1</sup>Call for pricing.

## Retail Price

Finish			PGE	PCY	DMY R/L Single	DMY R/L Pair	ML -F ENTRY
26/32D	RP		\$ 178.00	\$ 198.00	\$ 90.00		\$ 734.00
Finish			PGE	PCY	DMY R/L Single	DMY R/L Pair	ML -F ENTRY
26/32D	EP		\$ 360.00	\$ 393.00	\$ 197.00	\$ 335.00	\$ 640.00
		ER	\$ 431.00	\$ 442.00	\$ 207.00	\$ 371.00	\$ 670.00

Door knobs/  
Pomoli



# K 1168 Serie Giasone





design Valli Workshop

Material Brass/Materiale Ottone



## Matching elements/Coordinato

- Pg 135** Mortise lock functions
- Pg 144** Deadbolts/Privacy Bolts
- Pg 149** Escutcheons with deadbolts
- Pg 153** Multi-Point Trim functions

Finish			PGE	PCY	DMY		Retail price	
					R/L Single	R/L Pair	ML-F ENTRY	
26			<b>RP</b>	\$ 295.00	\$ 320.00	\$ 140.00	\$ 759.00	
			<b>RQ</b>	\$ 380.00	\$ 402.00	\$ 198.00	\$ 830.00	
26D			<b>RP</b>	\$ 290.00	\$ 310.00	\$ 145.00	\$ 759.00	
			<b>RQ</b>	\$ 395.00	\$ 417.00	\$ 210.00	\$ 830.00	
Finish			PGE	PCY	DMY		ML-F ENTRY	
					R/L Single	R/L Pair		
26			<b>EP</b>	\$ 412.00	\$ 430.00	\$ 199.00	\$ 354.00	\$ 670.00
			<b>ER</b>	\$ 453.00	\$ 457.00	\$ 218.00	\$ 393.00	\$ 699.00
26D			<b>EP</b>	\$ 412.00	\$ 430.00	\$ 199.00	\$ 354.00	\$ 670.00
			<b>ER</b>	\$ 453.00	\$ 457.00	\$ 218.00	\$ 393.00	\$ 699.00

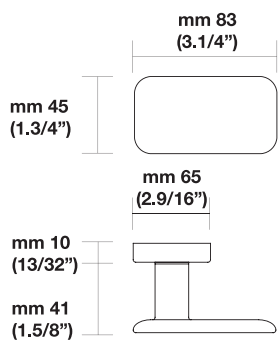

## Escutcheon options/Opzioni

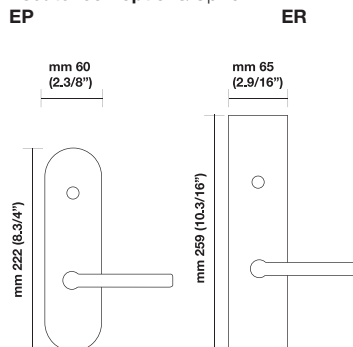

## Rosette options/Opzioni

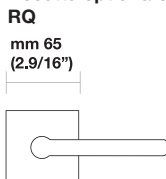

# K 4712

design Valli Workshop

Material Brass/Materiale Ottone









ASSA ABLOY



Matching elements/Coordinato

Pg 135 Mortise lock functions

Pg 144 Deadbolts/Privacy Bolts

Finish	 	PGE	PCY	DMY R/L Single	Retail price
					ML-F ENTRY
 03	RT	\$ 196.00	\$ 199.00	\$ 99.00	\$ 734.00
 06B	RT	\$ 196.00	\$ 199.00	\$ 108.00	\$ 734.00
 26	RT	\$ 196.00	\$ 199.00	\$ 99.00	\$ 734.00
 26D	RT	\$ 196.00	\$ 199.00	\$ 99.00	\$ 734.00

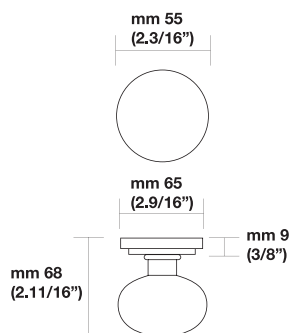

**Note:** Not available with long escutcheon. Not available with multi point.

# K 4714

design Valli Workshop







Material Brass/Materiale Ottone



Matching elements/Coordinato

Pg 135 Mortise lock functions

Pg 144 Deadbolts/Privacy Bolts

Finish	 	PGE	PCY	DMY R/L Single	Retail price
					ML-F ENTRY
 03	<b>RP</b>	\$ 260.00	\$ 278.00	\$ 125.00	\$ 734.00
 06B	<b>RP</b>	\$ 270.00	\$ 290.00	\$ 130.00	\$ 734.00
 26	<b>RP</b>	\$ 282.00	\$ 293.00	\$ 135.00	\$ 734.00
 26D	<b>RP</b>	\$ 282.00	\$ 294.00	\$ 135.00	\$ 734.00

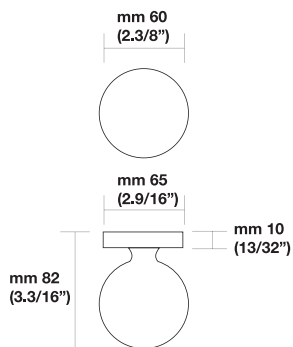





Door pulls/  
Maniglioni

# K 1188

design Valli Workshop

Material Brass/Materiale Ottone



Finish	Size	Center to center <sup>◆◆</sup>	Retail price
 03	mm 260x58x80 [10.1/4"x2.1/4"x3.1/8"]	mm 210 [8.1/4"]	\$ 189.00
 03D	mm 260x58x80 [10.1/4"x2.1/4"x3.1/8"]	mm 210 [8.1/4"]	\$ 189.00
 06B	mm 260x58x80 [10.1/4"x2.1/4"x3.1/8"]	mm 210 [8.1/4"]	\$ 198.00
 26D	mm 260x58x80 [10.1/4"x2.1/4"x3.1/8"]	mm 210 [8.1/4"]	\$ 198.00
 ZIRTANIO	mm 260x58x80 [10.1/4"x2.1/4"x3.1/8"]	mm 210 [8.1/4"]	\$ 341.00

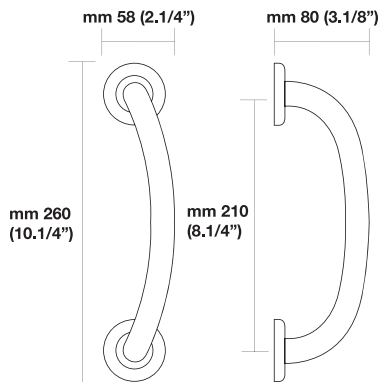

# K 1210 Serie Mizar





design Eero Aarnio

Material Brass/Materiale Ottone



ASSA ABLOY



Finish	Size	Center to center <sup>↕↕</sup>	Retail price	
	03	mm 260x79x70 [10.1/4"x3.1/8"x2.3/4"]	mm 210 [8.1/4"]	\$ 214.00
	03D	mm 260x79x70 [10.1/4"x3.1/8"x2.3/4"]	mm 210 [8.1/4"]	\$ 214.00
	06	mm 260x79x70 [10.1/4"x3.1/8"x2.3/4"]	mm 210 [8.1/4"]	\$ 223.00
	26D	mm 260x79x70 [10.1/4"x3.1/8"x2.3/4"]	mm 210 [8.1/4"]	\$ 224.00
	Zirtanio	mm 260x79x70 [10.1/4"x3.1/8"x2.3/4"]	mm 210 [8.1/4"]	\$ 355.00

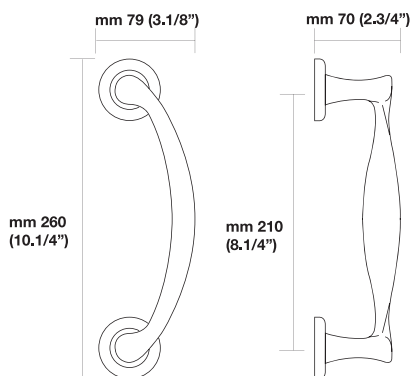

Possibility of mounting without cover-nut rosettes/Possibilità di montaggio senza rosette coprivite

Conversions from metric to U.S. measurements are approximate.

# K 1219

design Valli Workshop

Material Stainless steel AISI 304/Materiale Acciaio Inox 304



## K 1219 SINGLE

Finish	Length x Width	Center to center <sup>◇◇</sup>	Retail price
32D	239x15x43 [9.7/16"x9/16"x1.11/16"]	mm 224 [8.13/16"]	\$ 78.00

## K 1219/K 1219 S BACK TO BACK

Finish	Length x Width	Center to center <sup>◇◇</sup>	Retail price
32D	239x15x43 [9.7/16"x9/16"x1.11/16"]	mm 224 [8.13/16"]	\$ 155.00

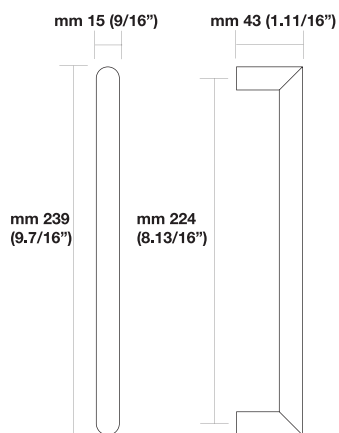

**Complete with fixing systems for single mounting and pairs on wood and glass**

Completo di dispositivi di fissaggio per montaggio singolo o in coppia su legno, in coppia su vetro

Conversions from metric to U.S. measurements are approximate.

# K 1224

design Valli Workshop

Material Stainless steel AISI 304/Materiale Acciaio Inox 304



ASSA ABLOY



## K 1224 SINGLE

Finish	Length x Width	Center to center <sup>◆◆</sup>	Retail price
32D	239x15x43 [9.7/16"x9/16"x1.11/16"]	mm 224 [8.13/16"]	\$ 99.00

## K 1224/K 1224 S BACK TO BACK

Finish	Length x Width	Center to center <sup>◆◆</sup>	Retail price
32D	239x15x43 [9.7/16"x9/16"x1.11/16"]	mm 224 [8.13/16"]	\$ 198.00

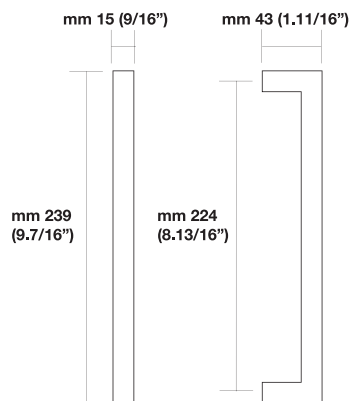

**Complete with fixing systems for single mounting and pairs on wood and glass**

Completo di dispositivi di fissaggio per montaggio singolo o in coppia su legno, in coppia su vetro

Conversions from metric to U.S. measurements are approximate.





# K 1226 Serie Fedra

design Jean Baptiste Sibertin Blanc

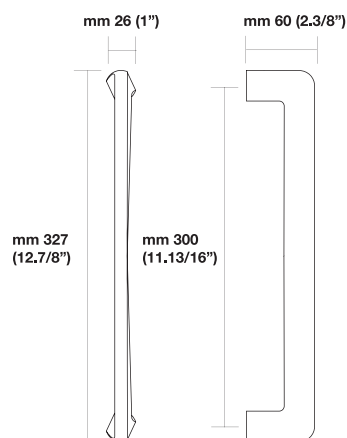
Material Brass/Materiale Ottone



## K 1226 SINGLE

Finish	Size	Center to center <sup>◆◆</sup>	Retail price
 03	327x26x60 [12.7/8"x1"x2.3/8"]	mm 300 [11.13/16"]	\$ 290.00
 26D/26	327x26x60 [12.7/8"x1"x2.3/8"]	mm 300 [11.13/16"]	\$ 301.00

## K 1226/K 1226 S BACK TO BACK

Finish	Size	Center to center <sup>◆◆</sup>	Retail price
 03	327x26x60 [12.7/8"x1"x2.3/8"]	mm 300 [11.13/16"]	\$ 617.00
 26D/26	327x26x60 [12.7/8"x1"x2.3/8"]	mm 300 [11.13/16"]	\$ 640.00

Complete with fixing systems for single mounting and pairs on wood and glass

Completo di dispositivi di fissaggio per montaggio singolo o in coppia su legno, in coppia su vetro

Conversions from metric to U.S. measurements are approximate.

# K 1228 Serie Bess

design Yoshimi Kono

Material Solid Brass/Materiale Ottone



ASSA ABLOY

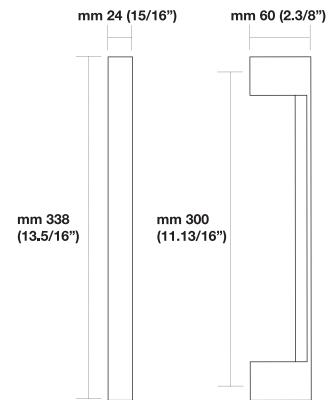

## K 1228 SINGLE

Finish	Length x Width	Center to center $\diamond\diamond$	Retail price
26	338x24x60 [13.5/16"x15/16"x2.3/8"]	mm 300 [11.13/16"]	\$ 298.00

## K 1228/K 1228 S BACK TO BACK

Finish	Length x Width	Center to center $\diamond\diamond$	Retail price
26	338x24x60 [13.5/16"x15/16"x2.3/8"]	mm 300 [11.13/16"]	\$ 634.00

Complete with fixing systems for single mounting and pairs on wood and glass

Completo di dispositivi di fissaggio per montaggio singolo o in coppia su legno, in coppia su vetro

Conversions from metric to U.S. measurements are approximate.

Coat hooks/  
Appendiabiti

# E 180



design Cini Boeri

Material Brass/Materiale Ottone

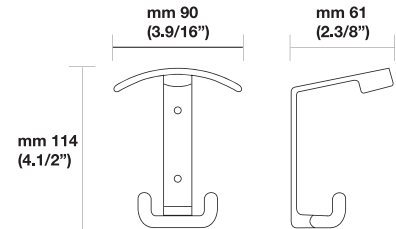

ASSA ABLOY







Finish	Length x Width	Retail price
 03	mm 114x90x61 [4.1/2"x3.9/16"x2.3/8"]	\$ 70.00
 26D	mm 114x90x61 [4.1/2"x3.9/16"x2.3/8"]	\$ 63.00

# E 182

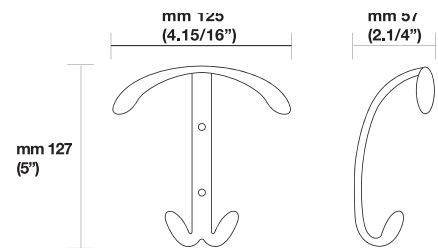
design Valli Workshop

Material Brass/Materiale Ottone







Finish	Length x Width	Retail price
 03	mm 127x125x57 [5"x4.15/16"x2.1/4"]	\$ 43.00
 06B	mm 127x125x57 [5"x4.15/16"x2.1/4"]	\$ 52.00
 26	mm 127x125x57 [5"x4.15/16"x2.1/4"]	\$ 47.00
 26D	mm 127x125x57 [5"x4.15/16"x2.1/4"]	\$ 45.00

# E 183

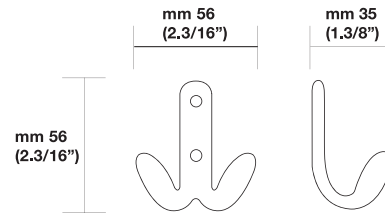
design Valli Workshop

Material Brass/Materiale Ottone





Finish	Length x Width	Retail price
 03	mm 56x56x35 [2.3/16"x2.3/16"x1.3/8"]	\$ 21.00
 06B	mm 56x56x35 [2.3/16"x2.3/16"x1.3/8"]	\$ 27.00
 26	mm 56x56x35 [2.3/16"x2.3/16"x1.3/8"]	\$ 21.00
 26D	mm 56x56x35 [2.3/16"x2.3/16"x1.3/8"]	\$ 23.00

# E 525

design Valli Workshop

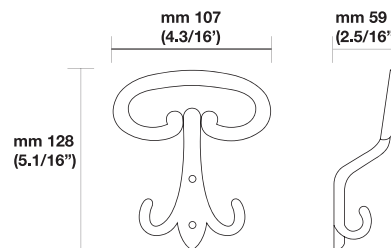
Material Nikrall Zamak alloy UNI 3717/Materiale Nikrall Lega Zama UNI 3717



Finish	Length x Width	Retail price
 06	mm 128x107x59 [5.1/16"x4.3/16"x2.5/16"]	\$ 24.00
 Iron	mm 128x107x59 [5.1/16"x4.3/16"x2.5/16"]	\$ 19.00

# E 1009

design Valli Workshop

Material Brass/Materiale Ottone



ASSA ABLOY

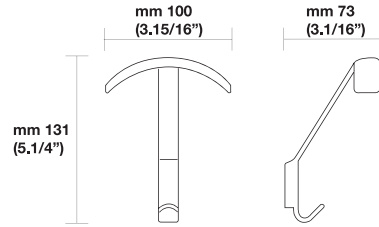

**Finish**

**Length x Width**

**Retail price**

26D

mm 131x100x73 [5.1/4"x3.15/16"x3.1/16"]

\$ 77.00

Pocket doors-  
Flush pulls/  
Maniglie  
per incasso





# K 1186

design Valli Workshop

Material Brass/Materiale Ottone





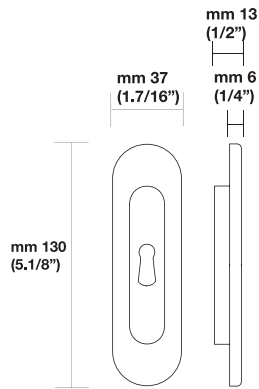



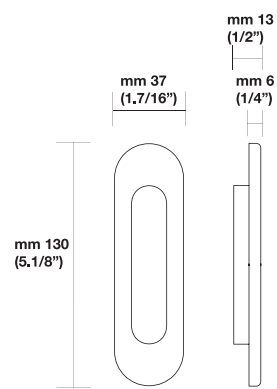

K 1186











K 1186 SFC



## K 1186 Key hole

Finish	Size	Retail price
 03	mm 130x37x13 [5.1/8"x1.7/16"x1/2"]	\$ 59.00
 03D	mm 130x37x13 [5.1/8"x1.7/16"x1/2"]	\$ 59.00
 06A	mm 130x37x13 [5.1/8"x1.7/16"x1/2"]	\$ 62.00
 06B	mm 130x37x13 [5.1/8"x1.7/16"x1/2"]	\$ 59.00
 15	mm 130x37x13 [5.1/8"x1.7/16"x1/2"]	\$ 74.00
 26	mm 130x37x13 [5.1/8"x1.7/16"x1/2"]	\$ 59.00
 26D	mm 130x37x13 [5.1/8"x1.7/16"x1/2"]	\$ 62.00
 Natural brass	mm 130x37x13 [5.1/8"x1.7/16"x1/2"]	\$ 59.00

## K 1186 SFC without key hole

Finish	Size	Retail price
 03	mm 130x37x13 [5.1/8"x1.7/16"x1/2"]	\$ 59.00
 03D	mm 130x37x13 [5.1/8"x1.7/16"x1/2"]	\$ 59.00
 06A	mm 130x37x13 [5.1/8"x1.7/16"x1/2"]	\$ 62.00
 06B	mm 130x37x13 [5.1/8"x1.7/16"x1/2"]	\$ 59.00
 15	mm 130x37x13 [5.1/8"x1.7/16"x1/2"]	\$ 74.00
 26	mm 130x37x13 [5.1/8"x1.7/16"x1/2"]	\$ 59.00
 26D	mm 130x37x13 [5.1/8"x1.7/16"x1/2"]	\$ 62.00
 Natural brass	mm 130x37x13 [5.1/8"x1.7/16"x1/2"]	\$ 59.00

# K 1195 Serie Bess

design Yoshimi Kono

Material Brass/Materiale Ottone



ASSA ABLOY

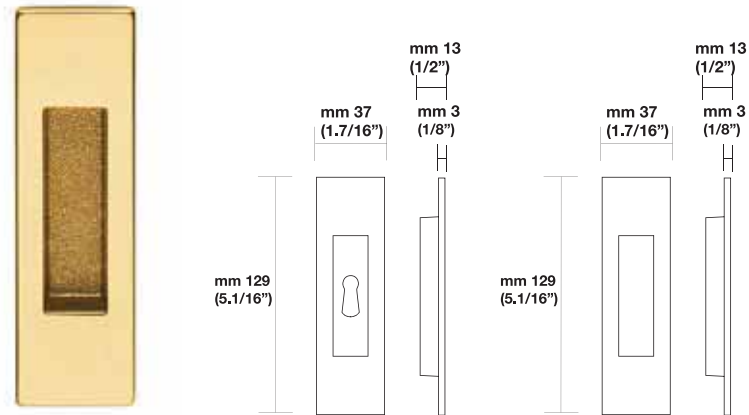

## K 1195 Key hole

Finish	Size	Retail price
26	mm 129x37x13 [5.1/16"x1.7/16"x1/2"]	\$ 65.00
26D	mm 129x37x13 [5.1/16"x1.7/16"x1/2"]	\$ 68.00

## K 1195 SFC without key hole

Finish	Size	Retail price
26	mm 129x37x13 [5.1/16"x1.7/16"x1/2"]	\$ 65.00
26D	mm 129x37x13 [5.1/16"x1.7/16"x1/2"]	\$ 68.00

# K 1200 Serie Trittico

design Valli Workshop

Material Brass/Materiale Ottone

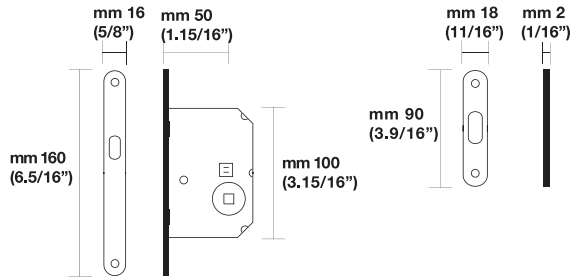
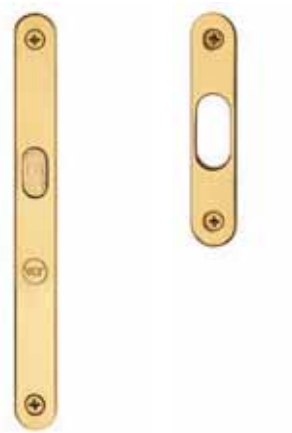
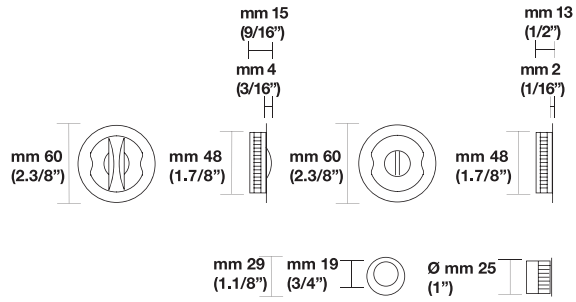

## K 1200 Privacy

Retail price



Finish	Size	1.3/4"
03	mm 60x15x13 [2.3/8"x9/16"x1/2"]	\$ 195.00
03D	mm 60x15x13 [2.3/8"x9/16"x1/2"]	\$ 195.00
06A	mm 60x15x13 [2.3/8"x9/16"x1/2"]	\$ 195.00
06B	mm 60x15x13 [2.3/8"x9/16"x1/2"]	\$ 195.00
26	mm 60x15x13 [2.3/8"x9/16"x1/2"]	\$ 214.00
26D	mm 60x15x13 [2.3/8"x9/16"x1/2"]	\$ 214.00
Natural brass	mm 60x15x13 [2.3/8"x9/16"x1/2"]	\$ 213.00

### NOTE

Privacy flush pulls accommodate 1.3/4" thickness only.

**Pocket door kit with thumb turn complete with lock and recessed finger pull.**

**K 1200 = Pocket door thumb turn do not flush complete.**

Split finishes available.

Add \$150.00 list to the highest priced finish.

# K 1201 Serie Trittico

design Valli Workshop

Material Brass/Materiale Ottone





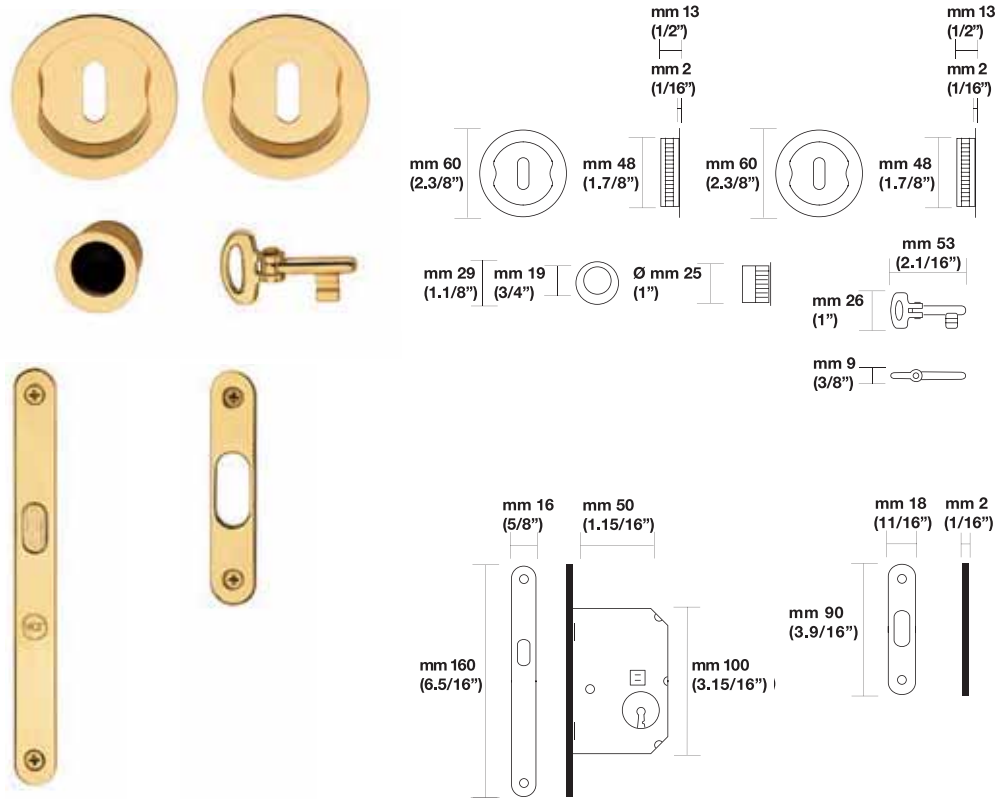

ASSA ABLOY



## K 1201 Privacy

Retail price

Finish	Size	1.3/4"
	03 mm 60x48x13 [2.3/8"x1.7/8"x1/2"]	\$ 162.00
	03D mm 60x48x13 [2.3/8"x1.7/8"x1/2"]	\$ 162.00
	06A mm 60x48x13 [2.3/8"x1.7/8"x1/2"]	\$ 162.00
	26 mm 60x48x13 [2.3/8"x1.7/8"x1/2"]	\$ 179.00
	26D mm 60x48x13 [2.3/8"x1.7/8"x1/2"]	\$ 179.00

### NOTE

Privacy flush pulls accommodate 1.3/4" thickness only.

**Pocket door kit with thumb turn complete with lock and recessed finger pull.**

Split finishes available.

Add \$150.00 list to the highest priced finish.

Conversions from metric to U.S. measurements are approximate.

# K 1202 Serie Trittico

design Valli Workshop

Material Brass/Materiale Ottone

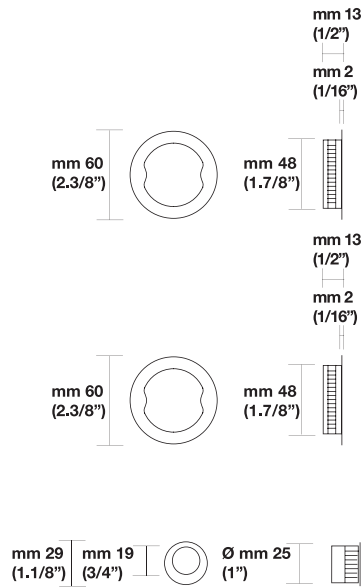

## K 1202



Finish	Size	Retail price
03	mm 60x48x13 [2.3/8"x1.7/8"x1/2"]	\$ 97.00
03D	mm 60x48x13 [2.3/8"x1.7/8"x1/2"]	\$ 97.00
06A	mm 60x48x13 [2.3/8"x1.7/8"x1/2"]	\$ 97.00
06B	mm 60x48x13 [2.3/8"x1.7/8"x1/2"]	\$ 97.00
26	mm 60x48x13 [2.3/8"x1.7/8"x1/2"]	\$ 108.00
26D	mm 60x48x13 [2.3/8"x1.7/8"x1/2"]	\$ 108.00

### NOTE

Flush pulls accommodate 1.3/8 and 1.3/4" door thickness.  
**Pocket door with recessed finger pull, without lock.**  
 Split finishes available.  
 Add \$150.00 list to the highest priced finish.

# K 1203 Serie Trittico

design Valli Workshop





Material Brass/Materiale Ottone



ASSA ABLOY



## K 1203

	Finish	Ø Diameter	Retail price
	03	mm 25 [1"]	\$ 24.00
	03D	mm 25 [1"]	\$ 24.00
	06A	mm 25 [1"]	\$ 24.00
	26	mm 25 [1"]	\$ 26.00
	26D	mm 25 [1"]	\$ 26.00

### NOTE

Recessed finger pull.

Conversions from metric to U.S. measurements are approximate.

# K 1204 Serie Tancredi

design Valli Workshop

Material Brass/Materiale Ottone

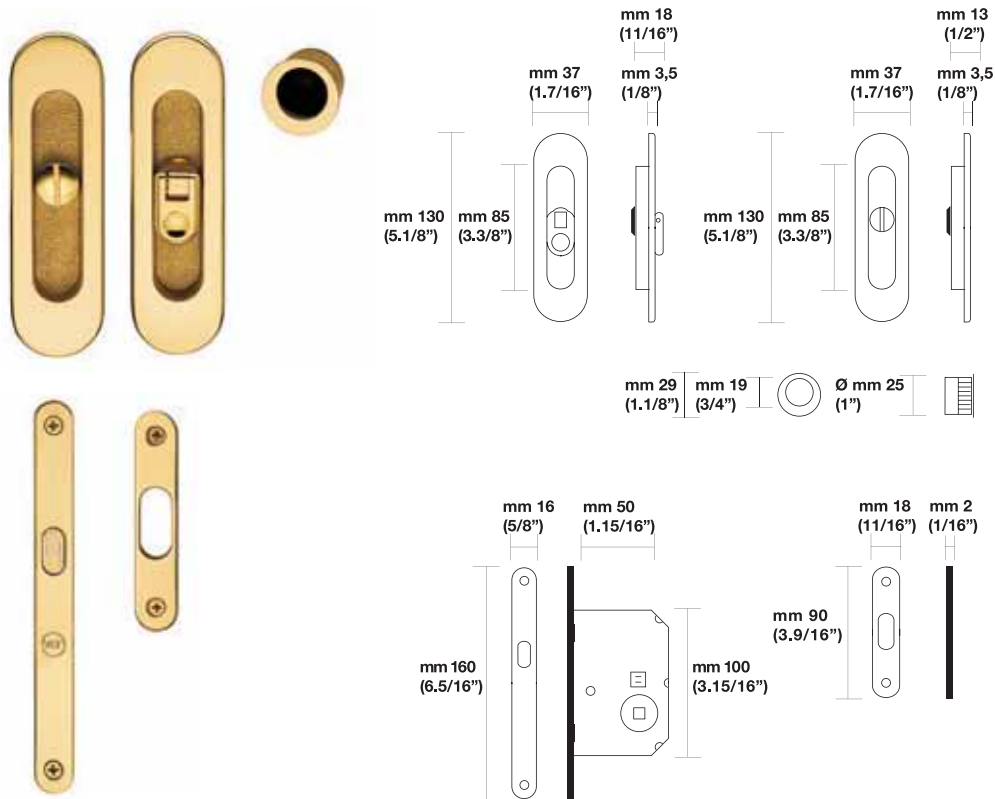

## K 1204 Privacy

Retail price

Finish	Size	1.3/4"
03	mm 130x37x18 [5.1/8"x1.7/16"x11/16"]	\$ 202.00
03D	mm 130x37x18 [5.1/8"x1.7/16"x11/16"]	\$ 202.00
06A	mm 130x37x18 [5.1/8"x1.7/16"x11/16"]	\$ 202.00
26	mm 130x37x18 [5.1/8"x1.7/16"x11/16"]	\$ 223.00
26D	mm 130x37x18 [5.1/8"x1.7/16"x11/16"]	\$ 223.00

### NOTE

Privacy flush pulls accommodate 1.3/4" thickness only.  
7/32 Thumbturn protrudes from surface plate.

**Pocket door kit with thumbturn complete with lock and recessed finger pull.**  
**K 1204 = Pocket door thumbturn do not flush complete.**

Split finishes available.

Add \$150.00 list to the highest priced finish.

# K 1205 Serie Tancredi

design Valli Workshop





Material Brass/Materiale Ottone

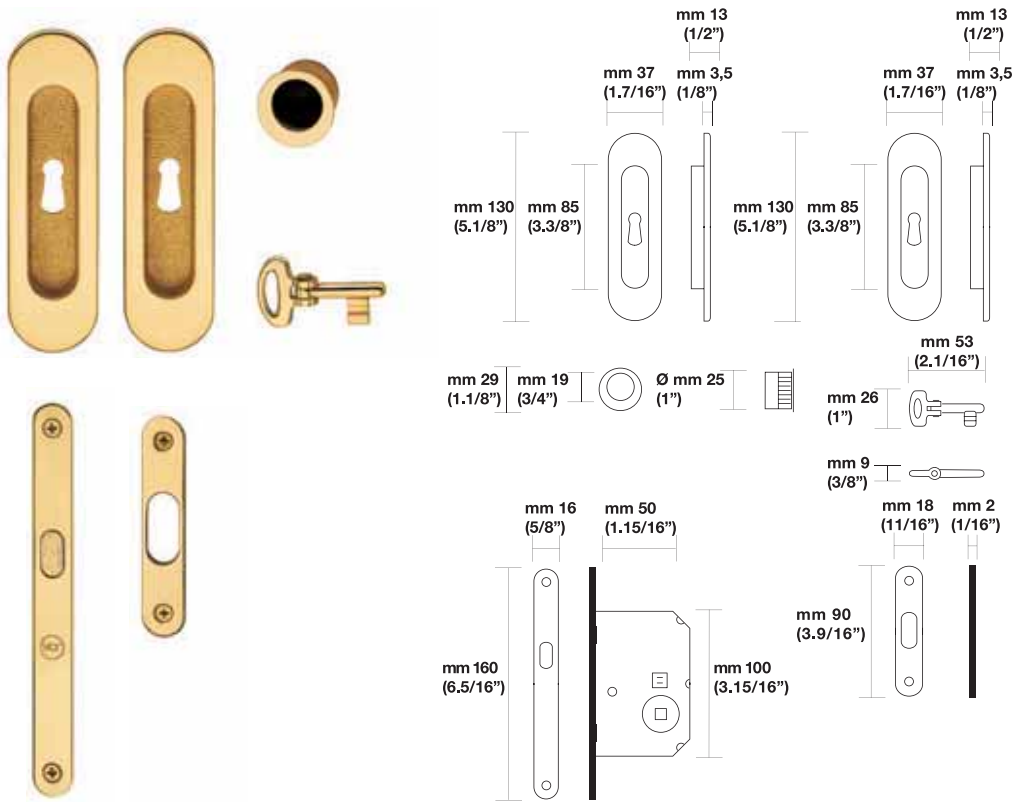

ASSA ABLOY



## K 1205 Privacy

Finish	Size	Retail price
		1.3/4"
	03 mm 130x37x13 [5.1/8"x1.7/16"x1/2"]	\$ 174.00
	03D mm 130x37x13 [5.1/8"x1.7/16"x1/2"]	\$ 174.00
	06A mm 130x37x13 [5.1/8"x1.7/16"x1/2"]	\$ 174.00
	26 mm 130x37x13 [5.1/8"x1.7/16"x1/2"]	\$ 186.00
	26D mm 130x37x13 [5.1/8"x1.7/16"x1/2"]	\$ 186.00

### NOTE

Privacy flush pulls accommodate 1.3/4" thickness only.

**Pocket door kit with thumbturn complete with lock and recessed finger pull.**

Split finishes available.

Add \$150.00 list to the highest priced finish.

Conversions from metric to U.S. measurements are approximate.



# K 1206 Serie Tancredi

design Valli Workshop

Material Brass/Materiale Ottone

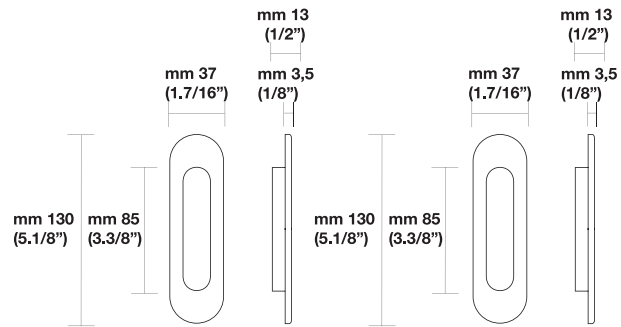

## K 1206



Finish	Size	Retail price
03	mm 130x37x13 [5.1/8"x1.7/16"x1/2"]	\$ 121.00
03D	mm 130x37x13 [5.1/8"x1.7/16"x1/2"]	\$ 121.00
06A	mm 130x37x13 [5.1/8"x1.7/16"x1/2"]	\$ 121.00
26	mm 130x37x13 [5.1/8"x1.7/16"x1/2"]	\$ 133.00
26D	mm 130x37x13 [5.1/8"x1.7/16"x1/2"]	\$ 133.00

### NOTE

Flush pulls accommodate 1.3/8" and 1.3/4" door thickness.  
**Pocket door with recessed finger pull, without lock.**  
 Split finishes available.  
 Add \$150.00 list to the highest priced finish.

# K 1211 Serie Orfeide

design Scigno

Material Brass/Materiale Ottone



ASSA ABLOY

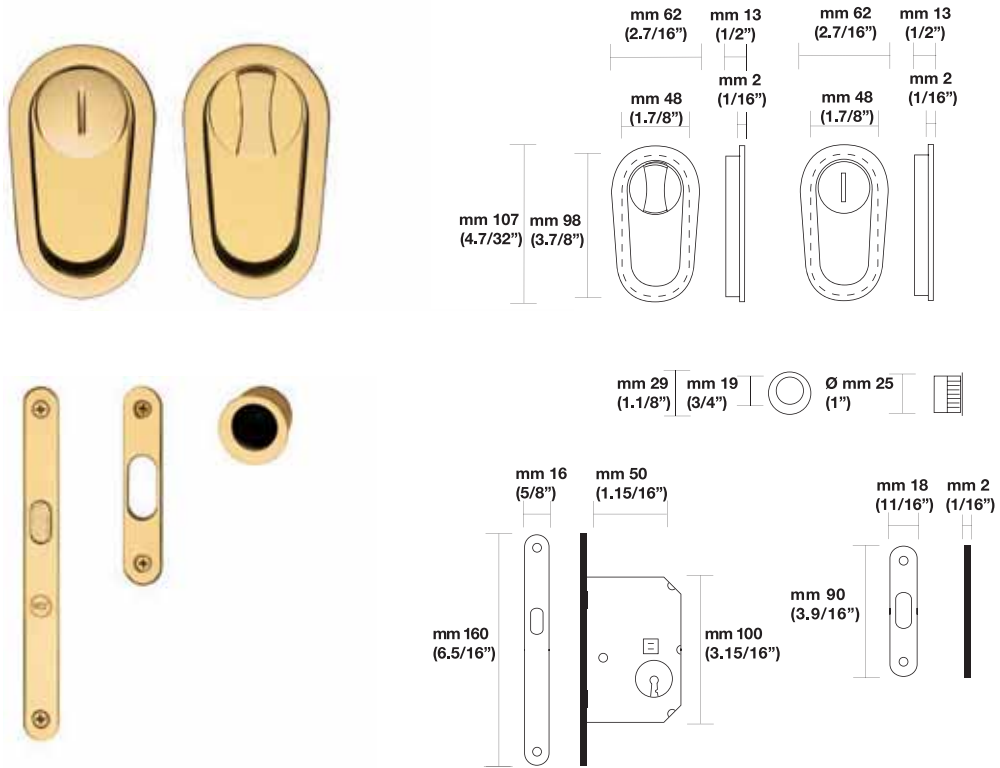

## K 1211 Privacy



Finish	Size	Retail price	
		1.3/4"	1.3/8"
03	mm 107x62x13 [4.7/32"x2.7/16"x1/2"]	\$ 297.00	\$ 359.00
14	mm 107x62x13 [4.7/32"x2.7/16"x1/2"]	\$ 339.00	\$ 410.00
15	mm 107x62x13 [4.7/32"x2.7/16"x1/2"]	\$ 323.00	\$ 385.00
26	mm 107x62x13 [4.7/32"x2.7/16"x1/2"]	\$ 308.00	\$ 359.00
26D	mm 107x62x13 [4.7/32"x2.7/16"x1/2"]	\$ 308.00	\$ 359.00

### NOTE

Privacy flush pulls accommodate 1.3/4" and 1.3/8" thickness. Please specify door thickness.  
 1.3/8" = require minimum pocket width 2.1/16" spacer will add 1/8" to surface of both sides of the door.  
**Pocket door kit with thumbturn complete with lock and recessed finger pull.**  
 Split finishes available.  
 Add \$150.00 list to the highest priced finish.

Conversions from metric to U.S. measurements are approximate.



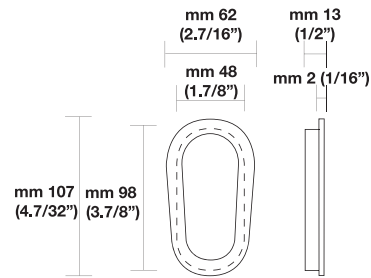
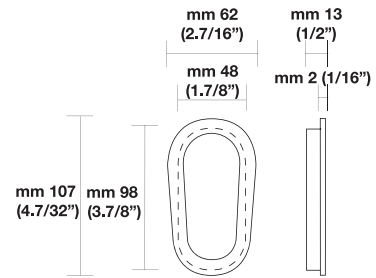

# K 1212 Serie Orfeide

design Scrigno

Material Brass/Materiale Ottone



## K 1212

Finish	Size	Retail price
 03	mm 107x62x13 [4.7/32"x2.7/16"x1/2"]	\$ 173.00
 14	mm 107x62x13 [4.7/32"x2.7/16"x1/2"]	\$ 217.00
 15	mm 107x62x13 [4.7/32"x2.7/16"x1/2"]	\$ 198.00
 26	mm 107x62x13 [4.7/32"x2.7/16"x1/2"]	\$ 190.00
 26D	mm 107x62x13 [4.7/32"x2.7/16"x1/2"]	\$ 182.00

### NOTE

Flush pulls accommodate 1.3/8" and 1.3/4" door thickness.  
**Pocket door with recessed finger pull, without lock.**  
 Split finishes available.  
 Add \$150.00 list to the highest priced finish.

# K 1230 Serie Bess

design Yoshimi Kono





Material Brass/Materiale Ottone

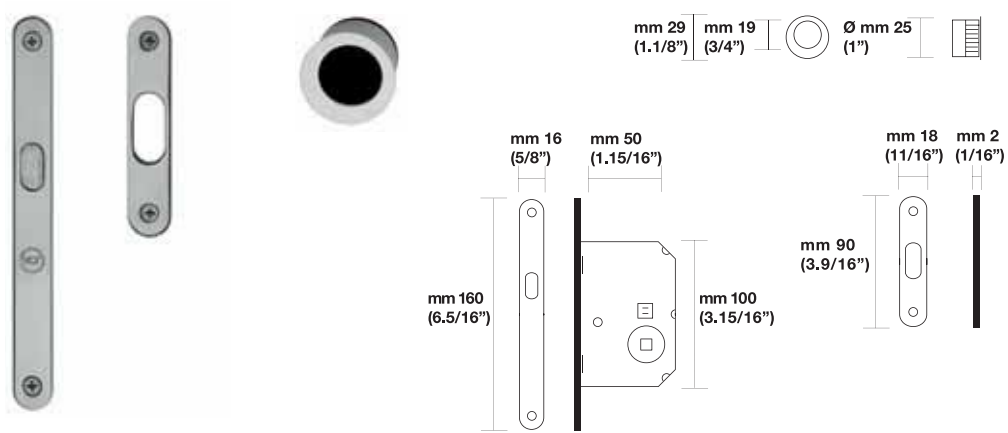
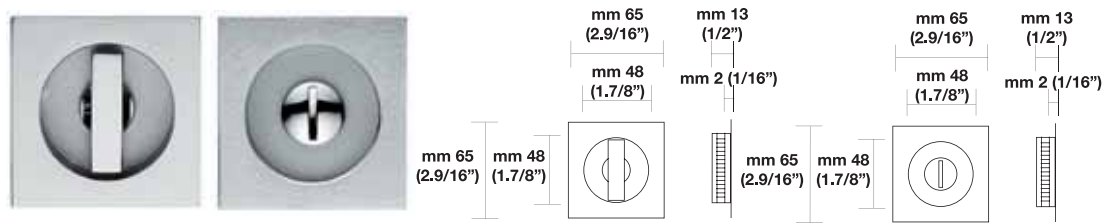

ASSA ABLOY



## K 1230 Privacy

Finish	Size	Retail price	
		1.3/4"	1.3/8"
	14 mm 65x65x13 [2.9/16"x2.9/16"x1/2"]	\$ 287.00	\$ 333.00
	15 mm 65x65x13 [2.9/16"x2.9/16"x1/2"]	\$ 287.00	\$ 333.00
	26 mm 65x65x13 [2.9/16"x2.9/16"x1/2"]	\$ 251.00	\$ 291.00
	26D mm 65x65x13 [2.9/16"x2.9/16"x1/2"]	\$ 263.00	\$ 300.00

### NOTE

Privacy flush pulls accommodate 1.3/4" and 1.3/8" thickness. Please specify door thickness.  
1.3/8" = require minimum pocket width 2.1/16" spacer will add 1/8" to surface of both sides of the door.

**Pocket door kit with thumbturn complete with lock and recessed finger pull.**

Split finishes available.

Add \$150.00 list to the highest priced finish.

Conversions from metric to U.S. measurements are approximate.



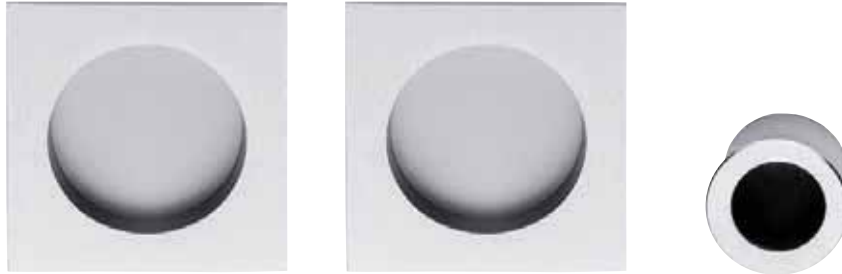

# K 1232 Serie Bess

design Yoshimi Kono

Material Brass/Materiale Ottone



## K1232

Finish	Size	Retail price
	14 mm 65x65x13 [2.9/16"x2.9/16"x1/2"]	\$ 145.00
	15 mm 65x65x13 [2.9/16"x2.9/16"x1/2"]	\$ 145.00
	26 mm 65x65x13 [2.9/16"x2.9/16"x1/2"]	\$ 126.00
	26D mm 65x65x13 [2.9/16"x2.9/16"x1/2"]	\$ 132.00

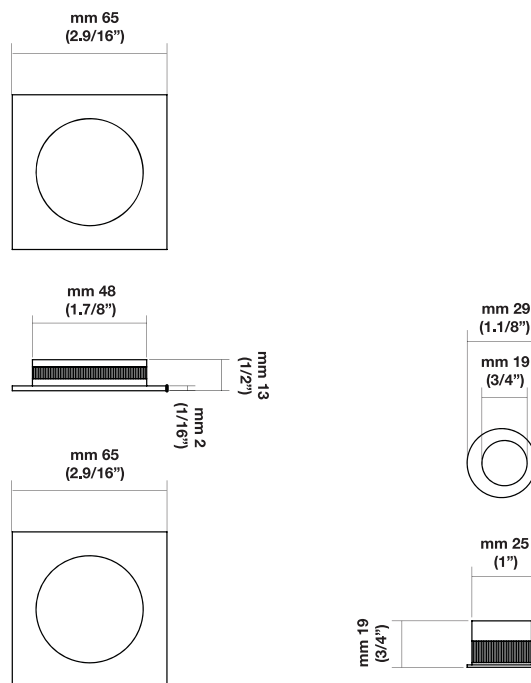

### NOTE

Flush pulls accommodate 1.3/8" and 1.3/4" door thickness.

**Pocket door with recessed finger pull, without lock.**

Split finishes available.

Add \$150.00 list to the highest priced finish.

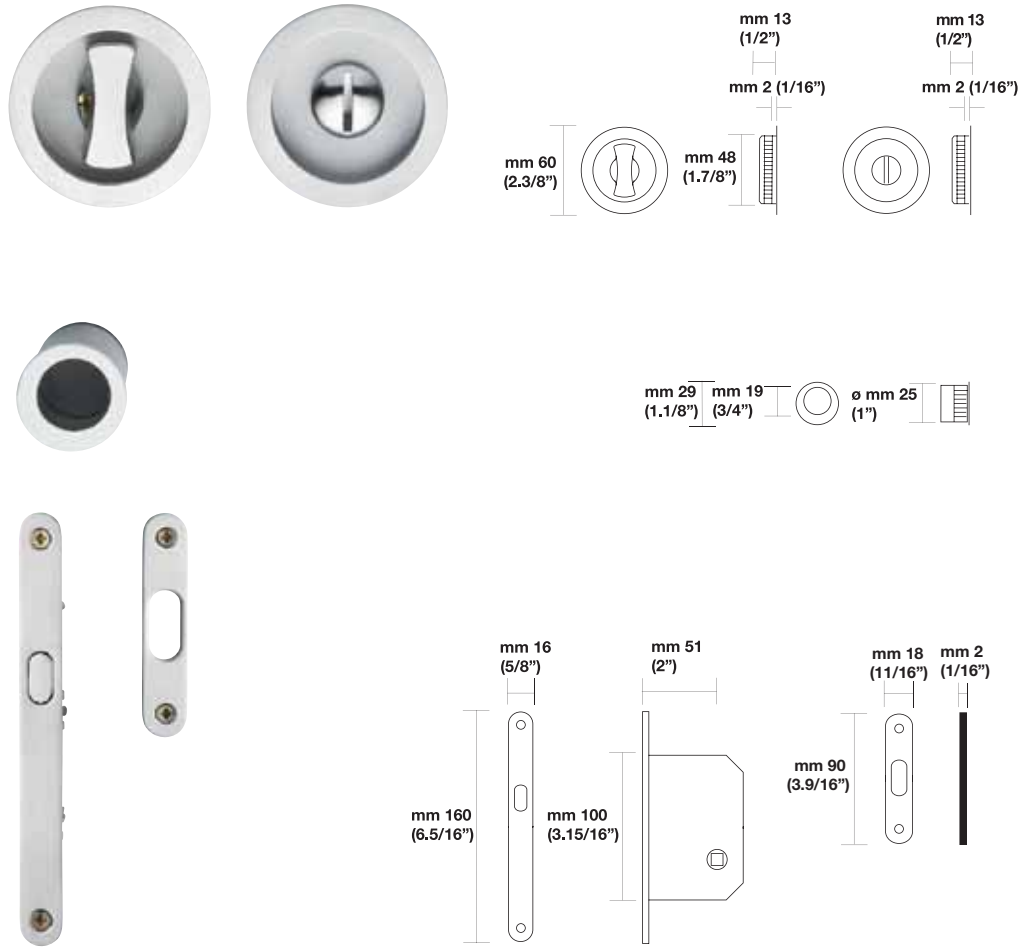

# K 4200

Material Brass/Materiale Ottone



## K 4200 Privacy

## Retail price

Finish	Diameter $\phi$	Size	Retail price	
			1.3/4"	1.3/8"
 03	mm 25 [1"]	mm 60x48x13 [2.3/8"x1.7/8"x1/2"]	\$ 101.00	\$215.00
 26	mm 25 [1"]	mm 60x48x13 [2.3/8"x1.7/8"x1/2"]	\$ 112.00	\$240.00
 26D	mm 25 [1"]	mm 60x48x13 [2.3/8"x1.7/8"x1/2"]	\$ 112.00	\$245.00

### NOTE

Privacy flush pulls accommodate 1.3/4" and 1.3/8" thickness. Please specify door thickness.  
1.3/8" = required minimum pocket width 2.1/16" spacer will add 1/8" to surface of both sides of the door.  
**Pocket door kit with thumbturn complete with lock and recessed finger pull.**  
Split finishes available.  
Add \$150.00 list to the highest priced finish.

Conversions from metric to U.S. measurements are approximate.

# K 4202

Material Brass/Materiale Ottone

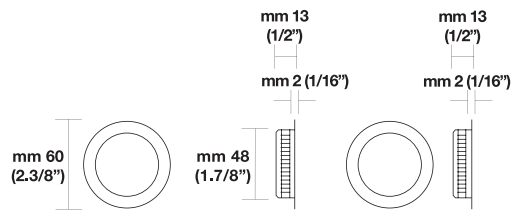

## K 4202



Finish	Diameter $\phi$	Size	Retail price
03	mm 25 [1"]	mm 60x48x13 [2.3/8"x1.7/8"x1/2"]	\$ 53.00
26	mm 25 [1"]	mm 60x48x13 [2.3/8"x1.7/8"x1/2"]	\$ 59.00
26D	mm 25 [1"]	mm 60x48x13 [2.3/8"x1.7/8"x1/2"]	\$ 59.00

### NOTE

Flush pulls accommodate 1.3/8" and 1.3/4" door thickness.

**Pocket door with recessed finger pull, without lock.**

Split finishes available.

Add \$150.00 list to the highest priced finish.

Conversions from metric to U.S. measurements are approximate.

Door stopper/  
Fermaporta





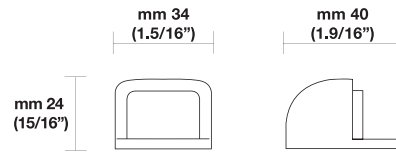

# L 190

design Valli Workshop

Material Brass/Materiale Ottone







Finish	Size	Retail price
	03 mm 34x24x40 [1.9/16"x15/16"x1.5/16"]	\$ 30.00
	06B mm 34x24x40 [1.9/16"x15/16"x1.5/16"]	\$ 30.00
	14 mm 34x24x40 [1.9/16"x15/16"x1.5/16"]	\$ 37.00
	26 mm 34x24x40 [1.9/16"x15/16"x1.5/16"]	\$ 30.00
	26D mm 34x24x40 [1.9/16"x15/16"x1.5/16"]	\$ 34.00

# L 193

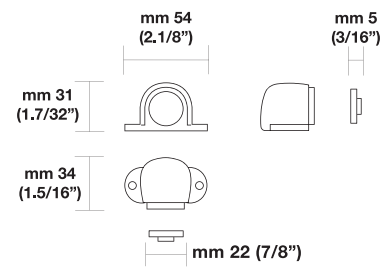
design Valli Workshop

Material Brass/Materiale Ottone



Finish	Size	Retail price
	03 mm 54x34x31 [2.1/8"x1.5/16"x1.7/32"]	\$ 72.00
	06A mm 54x34x31 [2.1/8"x1.5/16"x1.7/32"]	\$ 72.00
	26 mm 54x34x31 [2.1/8"x1.5/16"x1.7/32"]	\$ 72.00
	26D mm 54x34x31 [2.1/8"x1.5/16"x1.7/32"]	\$ 73.00

**NOTE**

L 190 Door stop, L 193 magnetic door stop 8 kgs strength.

Conversions from metric to U.S. measurements are approximate.

# L 490

Material Stainless steel AISI 304/Materiale Acciaio Inox AISI 304



Finish	Size	Retail price
32D	mm 34x35 [1.5/16"x1.3/8"]	\$ 26.00

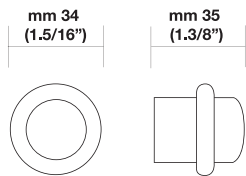

# Finishes

## U.S.A.

03 Polished Brass  
 03D Satin Brass  
 03/03D Polished Brass-Satin Brass  
 06 Antique Brass  
 06A Anticato  
 06B Brunito  
 10B Oil Rubbed Bronze  
 14 Polished Nickel  
 15 Satin Nickel  
 15A Antique Nickel  
 15/26 Satin Nickel-Polished Chrome  
 16 Dull Black  
 17 Orolux (brass finish)  
 17D Satin Orolux  
 18 Light Black  
 21 Black Enamel  
 22 White Enamel  
 24 Gold 24K  
 26 Polished Chrome  
 26D Satin Chrome  
 32 Polished Stainless Steel  
 32D Satin Stainless Steel  
 32D/15 Satin-Stainless Steel/Satin Nickel  
 ALU 7000 Aluminum  
 ALU 7011 Aluminum  
 Antique Gold  
 Antique Silver  
 Clear  
 Floral  
 Frosted Blue-15 Satin Nickel  
 Frosted Blue-03 Polished Brass  
 Frosted Light Blue-15 Satin Nickel  
 Frosted Light Blue-03 Polished Brass  
 Frosted Green-15 Satin Nickel  
 Frosted Green-03 Polished Brass  
 Frosted Pink-15 Satin Nickel  
 Frosted Pink-03 Polished Brass  
 Frosted Topaz-15 Satin Nickel  
 Frosted Topz-03 Polished Brass  
 Iron  
 Light Grey  
 Zinc-Plated

## ITALY

03 Oro  
 03D Orsatin  
 03/03D Oro-Orsatin  
 06 Patiné  
 06A Anticato  
 06B Brunito  
 10B Bronzoil  
 15 Nikmatt  
 15 Nikmatt  
 15A Niksatin  
 15/26 Nikmatt-Chromo  
 16 Neropaco  
 17 Orolux  
 17D Orolux Matt  
 18 Light Black  
 21 Nero  
 22 Bianco  
 24 Oro Zecchino  
 26 Cromo  
 26D Crowsatin  
 32 Lucido  
 32D Satinato  
 32D/15 Satinato-Nikmatt  
 Alu 7000  
 Alu 7011  
 Orant  
 Arant  
 Trasparente  
 Florato  
 Blu Opaco-Nikmatt  
 Blu Opaco-Oro  
 Azzurro Opaco-Nikmatt  
 Azzurro Opaco-Oro  
 Verde Opaco-Nikmatt  
 Verde Opaco-Oro  
 Rosa Opaco-Nikmatt  
 Rosa Opaco-Oro  
 Topazio Opaco-Nikmatt  
 Topazio Opaco-Oro  
 Fume  
 Light Grey  
 Zincato

# Cabinet hardware

Cabinet pulls/  
Maniglie

# A 163

design Sottsass Associati



**Brass**  
Ottone



Finish	Size	Center to center <sup>◇◇</sup>	Bar code	Retail price
03 Polished brass	<b>B</b>	64 mm [2.1/2"]	100647	\$ 17.80
26D Satin chrome	<b>B</b>	64 mm [2.1/2"]	002347	\$ 15.40
03 Polished brass	<b>C</b>	32 mm [1.1/4"]	101231	\$ 16.30
26D Satin chrome	<b>C</b>	32 mm [1.1/4"]	002354	\$ 13.70

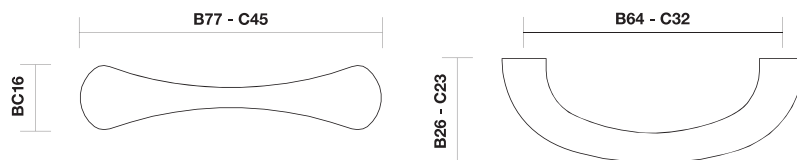

# A 230

design Valli Workshop



**Nikrall Zamak Alloy UNI 3717**  
Nikrall Lega Zama UNI 3717



Finish	Size	Center to center <sup>◇◇</sup>	Bar code	Retail price
15 Satin nickel	<b>A</b>	320 mm [12.5/8"]	623546	\$ 40.10
15 Satin nickel	<b>B</b>	224 mm [8.13/16"]	623553	\$ 33.50
15 Satin nickel	<b>C</b>	128 mm [5"]	623560	\$ 27.60



# A 231

design Valli Workshop

**Nikrall Zamak Alloy UNI 3717**

Nikrall Lega Zama UNI 3717



Finish	Size	Center to center <sup>◇◇</sup>	Bar code	Retail price
15 Satin nickel	<b>A</b>	320 mm [12.5/8"]	623607	\$ 40.10
15 Satin nickel	<b>B</b>	224 mm [8.13/16"]	623614	\$ 33.50
15 Satin nickel	<b>C</b>	128 mm [5"]	623621	\$ 27.60

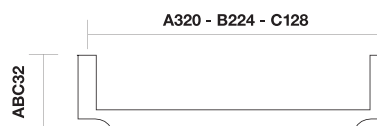
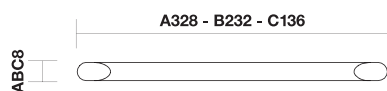

# A 237

design Eero Aarnio

**Nikrall Zamak Alloy UNI 3717**

Nikrall Lega Zama UNI 3717



Finish	Size	Center to center <sup>◇◇</sup>	Bar code	Retail price
15 Satin nickel	<b>A</b>	160 mm [6.5/16"]	630674	\$ 26.70
15 Satin nickel	<b>B</b>	128 mm [5"]	630650	\$ 21.90
15 Satin nickel	<b>C</b>	96 mm [3.3/4"]	630636	\$ 21.30

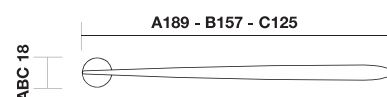

# A 240

design Eero Aarnio

Nikrall Zamak Alloy UNI 3717  
Nikrall Lega Zama UNI 3717

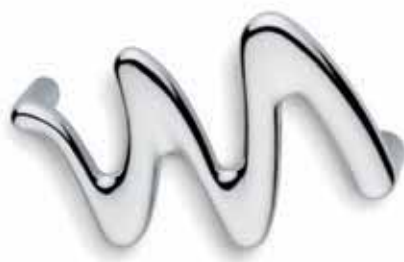

Finish	Size	Center to center $\diamond\diamond$	Bar code	Retail price
26 Chrome	<b>B</b>	96 mm [3.3/4"]	630803	\$ 20.40
26 Chrome	<b>C</b>	64 mm [2.1/2"]	630780	\$ 17.80

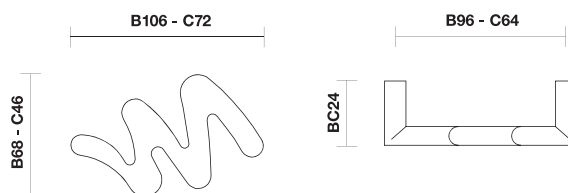

# A 252

design Eero Aarnio

Nikrall Zamak Alloy UNI 3717  
Nikrall Lega Zama UNI 3717



Finish	Size	Center to center $\diamond\diamond$	Bar code	Retail price
15 Satin nickel	<b>A</b>	224 mm [8.13/16"]	656230	\$ 39.80
15 Satin nickel	<b>B</b>	160 mm [6.5/16"]	641441	\$ 34.50
15 Satin nickel	<b>C</b>	128 mm [5"]	641458	\$ 28.80

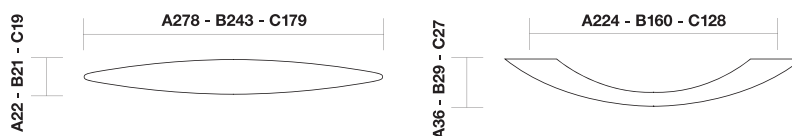

# A 256

design Eero Aarnio

**Nikrall Zamak Alloy UNI 3717**

Nikrall Lega Zama UNI 3717



Finish	Size	Center to center $\diamond\diamond$	Bar code	Retail price
15 Satin nickel	<b>A</b>	224 mm [8.13/16"]	645449	\$ 41.90
15 Satin nickel	<b>B</b>	160 mm [6.5/16"]	641465	\$ 28.00
15 Satin nickel	<b>C</b>	128 mm [5"]	641472	\$ 23.80
15 Satin nickel	<b>D</b>	96 mm [3.3/4"]	641489	\$ 22.70

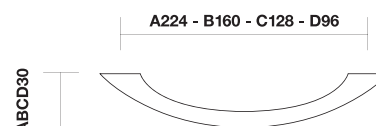
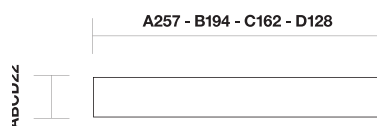

# A 275

design Valli Workshop

**Nikrall Zamak Alloy UNI 3717 and Brass**

Nikrall Lega Zama UNI 3717 e Ottone



Finish	Size	Center to center $\diamond\diamond$	Bar code	Retail price
15 Satin nickel	<b>C</b>	320 mm [12.5/8"]	653543	\$ 66.90
15 Satin nickel	<b>D</b>	224 mm [8.13/16"]	656988	\$ 53.40

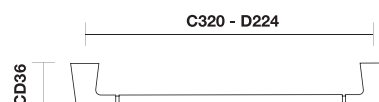
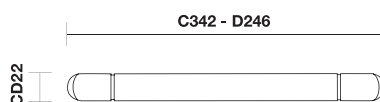



# A 278

design Eero Aarnio

**Nikrall Zamak Alloy UNI 3717**  
Nikrall Lega Zama UNI 3717



Finish	Size	Center to center <sup>◇◇</sup>	Bar code	Retail price
15 Satin nickel	<b>B</b>	128 mm [5"]	657060	\$ 28.00
15 Satin nickel	<b>C</b>	96 mm [3.3/4"]	657077	\$ 23.50



# A 282

design Valli Workshop

**Stainless steel**  
Acciaio inox



Finish	Size	Center to center <sup>◇◇</sup>	Bar code	Retail price
32D Satin	<b>A</b>	192 mm [7.9/16"]	128412	\$ 41.90
32D Satin	<b>B</b>	128 mm [5"]	128429	\$ 38.20
32D Satin	<b>C</b>	96 mm [3.3/4"]	128436	\$ 37.00

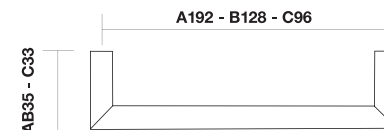
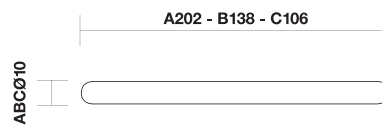

# A 283

design Valli Workshop

**Stainless steel**  
Acciaio inox



Finish	Size	Center to center <sup>◇◇</sup>	Bar code	Retail price
32D Satin	<b>A</b>	320 mm [12.5/8"]	128474	\$ 76.60
32D Satin	<b>B</b>	224 mm [8.13/16"]	128481	\$ 60.60
32D Satin	<b>C</b>	128 mm [5"]	128498	\$ 44.60

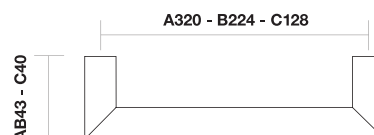
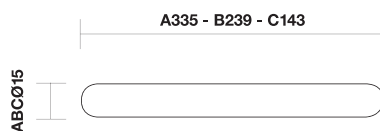

# A 284

design Eero Aarnio

**Nikrall Zamak Alloy UNI 3717**  
Nikrall Lega Zama UNI 3717



Finish	Size	Center to center <sup>◇◇</sup>	Bar code	Retail price
15 Satin nickel	<b>C</b>	32 mm [1.1/4"]	670229	\$ 22.70
26 Chrome	<b>C</b>	32 mm [1.1/4"]	670236	\$ 21.50

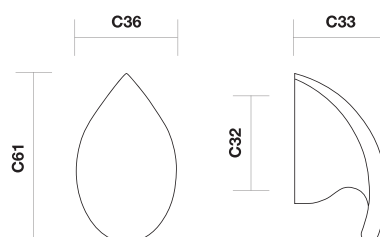

# A 288

design Giancarlo Vegni

**Nikrall Zamak Alloy UNI 3717 and Brass**  
Nikrall Lega Zama UNI 3717 e Ottone



Finish	Size	Center to center $\diamond\diamond$	Bar code	Retail price
15 Satin nickel	<b>B</b>	320 mm [12.5/8"]	670342	\$ 61.60
15 Satin nickel	<b>C</b>	224 mm [8.13/16"]	670359	\$ 56.20
15 Satin nickel	<b>D</b>	160 mm [6.3/8"]	668547	\$ 51.90

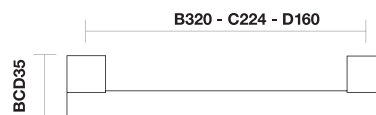
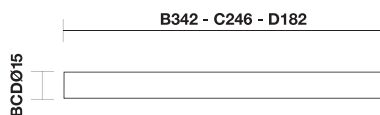

# A 295

design Giancarlo Vegni

**Nikrall Zamak Alloy UNI 3717 and Brass**  
Nikrall Lega Zama UNI 3717 e Ottone



Finish	Size	Center to center $\diamond\diamond$	Bar code	Retail price
26 Chrome	<b>B</b>	320 mm [12.5/8"]	675569	\$ 78.80
26D Satin chrome	<b>B</b>	320 mm [12.5/8"]	674074	\$ 84.20
26 Chrome	<b>C</b>	224 mm [8.13/16"]	675590	\$ 68.10
26D Satin chrome	<b>C</b>	224 mm [8.13/16"]	675583	\$ 78.10
26 Chrome	<b>D</b>	160 mm [6.5/16"]	675613	\$ 67.90
26D Satin chrome	<b>D</b>	160 mm [6.5/16"]	674067	\$ 74.70

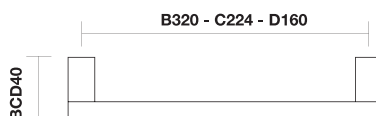
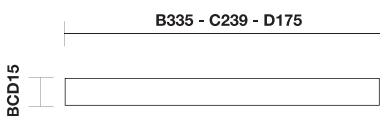

## A 752/2

design Valli Workshop



**Nikrall Zamak Alloy UNI 3717 and Wrought iron**  
Nikrall Lega Zama UNI 3717 e Ferro battuto



Finish	Size	Center to center <sup>✦✦</sup>	Bar code	Retail price
Iron	<b>A</b>	90 mm [4.7/16"]	601735	\$ 13.30
Iron	<b>B</b>	73 mm [3"]	601742	\$ 12.60

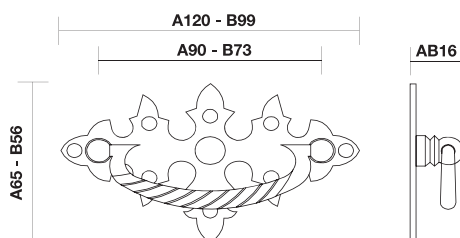

## A 753/2

design Valli Workshop



**Nikrall Zamak Alloy UNI 3717 and Wrought iron**  
Nikrall Lega Zama UNI 3717 e Ferro battuto



Finish	Size	Dimension	Bar code	Retail price
Iron	<b>B</b>	112 mm [4.7/16"]	601759	\$ 12.70
Iron	<b>C</b>	76 mm [3"]	601766	\$ 11.60

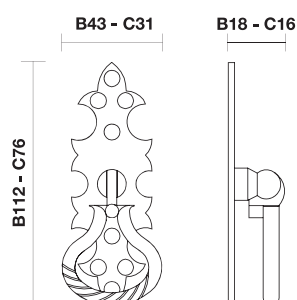

# A 755/2

design Valli Workshop

Brass  
Ottone



Finish	Size	Center to center <sup>◇◇</sup>	Bar code	Retail price
06 Antique brass	<b>A</b>	172 mm [6.7/8"]	000084	\$ 21.50

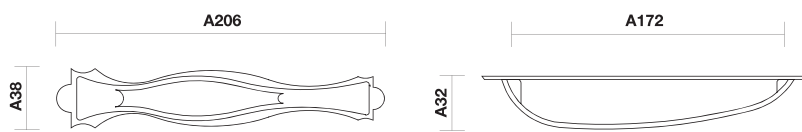

Finish	Size	Center to center <sup>◇◇</sup>	Bar code	Retail price
06 Antique brass	<b>B</b>	115 mm [4.1/2"]	000091	\$ 16.50
06 Antique brass	<b>C</b>	75 mm [2.15/16"]	000107	\$ 14.50

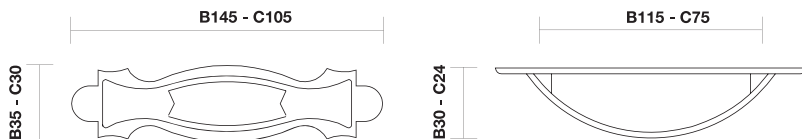

# A 791

design Valli Workshop



Brass  
Ottone



Finish	Size	Center to center <sup>◇◇</sup>	Bar code	Retail price
03 Brass	<b>B</b>	72 mm [2.13/16"]	000299	\$ 31.40
06 Antique brass	<b>B</b>	72 mm [2.13/16"]	000275	\$ 30.30
03 Brass	<b>C</b>	55 mm [2.1/8"]	000305	\$ 30.30
06 Antique brass	<b>C</b>	55 mm [2.1/8"]	000282	\$ 28.60

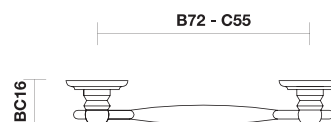
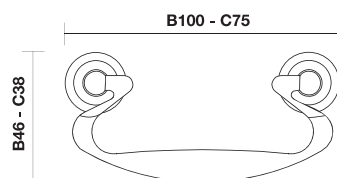

# A 792

design Valli Workshop



Brass  
Ottone



Finish	Size	Dimension	Bar code	Retail price
03 Brass	<b>B</b>	65mm [2.9/16"]	000336	\$ 23.80
06 Antique brass	<b>B</b>	65mm [2.9/16"]	000312	\$ 20.00
03 Brass	<b>C</b>	55 mm [2.1/8"]	000343	\$ 23.00
06 Antique brass	<b>C</b>	55 mm [2.1/8"]	000329	\$ 19.60

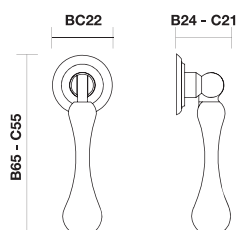

# A 2024

design Studio Carlesi Design

Nikrall Zamak Alloy UNI 3717

Nikrall Lega Zama UNI 3717



Finish	Size	Center to center <sup>◇◇</sup>	Bar code	Retail price
26 Chrome	<b>A</b>	320 mm [12.5/8"]	688064	\$ 46.90
26 Chrome	<b>B</b>	160 mm [6.5/6"]	688088	\$ 31.20
15 Satin Nickel	<b>B</b>	160 mm [6.5/16"]	688071	\$ 32.20



# A 2025

design Antonio Citterio

Stainless steel

Acciaio inox



Finish	Size	Center to center <sup>◇◇</sup>	Bar code	Retail price
32D Satin	<b>B</b>	320 mm [12.5/8"]	684479	\$ 98.40
32D Satin	<b>C</b>	224 mm [8.13/16"]	684486	\$ 89.10
32D Satin	<b>D</b>	160 mm [6.5/16"]	688118	\$ 85.70

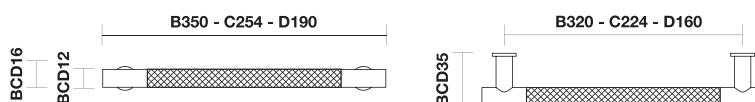

# A 2026

design Marianelli e Sordina

**Nikrall Zamak Alloy UNI 3717**  
Nikrall Lega Zama UNI 3717



Finish	Size	Center to center <sup>◆◆</sup>	Bar code	Retail price
15 Satin nickel	<b>A</b>	224 mm [8.13/16"]	688019	\$ 53.80
26 Chrome	<b>A</b>	224 mm [8.13/16"]	688026	\$ 53.10
15 Satin nickel	<b>B</b>	160 mm [6.5/16"]	688033	\$ 46.90
26 Chrome	<b>B</b>	160 mm [6.5/16"]	688040	\$ 46.30

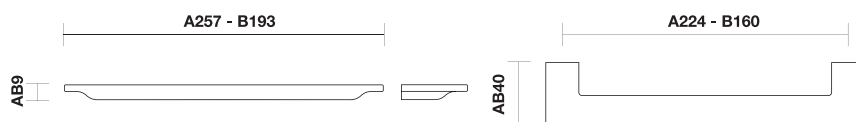

# A 2027

design Giancarlo Vegni

**Nikrall Zamak Alloy UNI 3717**  
Nikrall Lega Zama UNI 3717



Finish	Size	Center to center <sup>◆◆</sup>	Bar code	Retail price
15 Satin nickel	<b>A</b>	224 mm [8.13/16"]	687951	\$ 45.50
26 Chrome	<b>A</b>	224 mm [8.13/16"]	687968	\$ 43.50
15 Satin nickel	<b>B</b>	160 mm [6.5/16"]	687975	\$ 42.60
26 Chrome	<b>B</b>	160 mm [6.5/16"]	687982	\$ 40.30
15 Satin nickel	<b>C</b>	96 mm [3.3/4"]	687999	\$ 38.70
26 Chrome	<b>C</b>	96 mm [3.3/4"]	688002	\$ 36.70

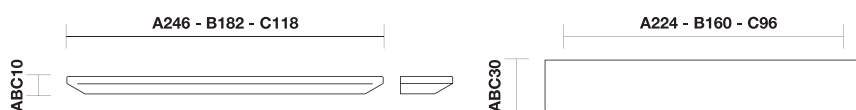



# A 2041

design Giancarlo Vegni

**Nikrall Zamak Alloy UNI 3717 and Brass**  
Nikrall Lega Zama UNI 3717 e Ottone



Finish	Size	Center to center <sup>✦✧</sup>	Bar code	Retail price
15 Satin nickel	<b>B</b>	320 mm [12.5/8"]	690081	\$ 72.50
26/26D Chrome Satin chrome	<b>B</b>	320 mm [12.5/8"]	695253	\$ 72.50
15 Satin nickel	<b>C</b>	224 mm [8.13/16"]	692023	\$ 68.60
26/26D Chrome Satin chrome	<b>C</b>	224 mm [8.13/16"]	695260	\$ 68.60
15 Satin nickel	<b>D</b>	160 mm [6.5/16"]	692030	\$ 66.40
26/26D Chrome Satin chrome	<b>D</b>	160 mm [6.5/16"]	695277	\$ 66.40

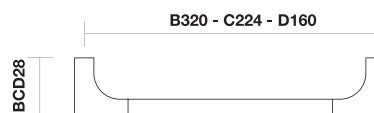
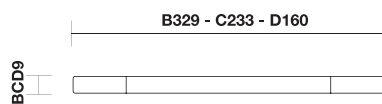

# A 2042

design Frank O. Gehry

**Nikrall Zamak Alloy UNI 3717**  
Nikrall Lega Zama UNI 3717



Finish	Size	Center to center <sup>✦✧</sup>	Bar code	Retail price
26 Chrome	<b>A</b>	160 mm [6.5/16"]	696045	\$ 53.10
26D Satin chrome	<b>A</b>	160 mm [6.5/16"]	695284	\$ 53.80
26 Chrome	<b>B</b>	128 mm [5"]	696052	\$ 49.90
26D Satin chrome	<b>B</b>	128 mm [5"]	695291	\$ 50.90

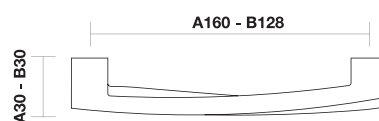

# A 2046

design Carlesi Design



**Nikrall Zamak Alloy UNI 3717**

Nikrall Lega Zama UNI 3717



Finish	Size	Center to center <sup>↕↕</sup>	Bar code	Retail price
15 Satin nickel	<b>B</b>	64 mm [2.1/2"]	705198	\$ 32.20
26 Chrome	<b>B</b>	64 mm [2.1/2"]	705181	\$ 31.10

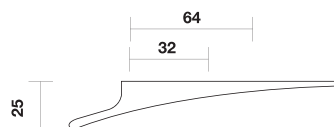
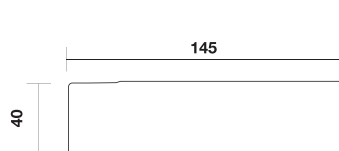

# A 2047

design Giancarlo Vegni



**Nikrall Zamak Alloy UNI 3717**

Nikrall Lega Zama UNI 3717



Finish	Size	Center to center <sup>↕↕</sup>	Bar code	Retail price
15 Satin nickel	<b>B</b>	160 mm [6.5/16"]	705112	\$ 36.20
15 Satin nickel	<b>C</b>	96 mm [3.3/4"]	705136	\$ 28.80

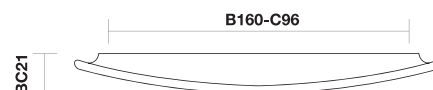
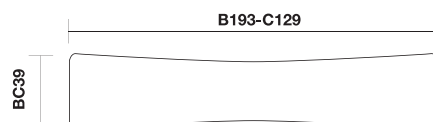

# A 2048

design Carlesi Design

**Nikrall Zamak Alloy UNI 3717**  
Nikrall Lega Zama UNI 3717



Finish	Size	Center to center <sup>✦✦</sup>	Bar code	Retail price
26 Chrome	<b>B</b>	128 mm [5"]	699916	\$ 43.20
26 Chrome	<b>C</b>	64 mm [1.1/2"]	699923	\$ 39.20

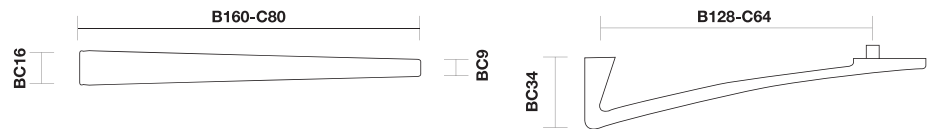

# A 2050

design Carlesi Design

**Nikrall Zamak Alloy UNI 3717**  
Nikrall Lega Zama UNI 3717



Finish	Size	Center to center <sup>✦✦</sup>	Bar code	Retail price
26 Chrome	<b>B</b>	16 mm [5/8"]	705167	\$ 38.80

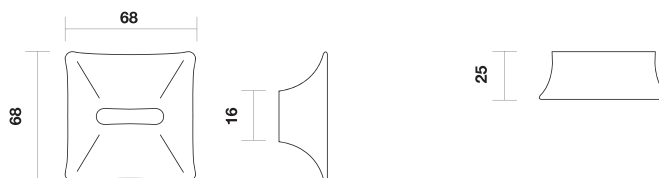

# A 2057

design Valli Workshop

**Nikrall Zamak Alloy UNI 3717**

Nikrall Lega Zama UNI 3717



Finish	Size	Center to center <sup>◇◇</sup>	Bar code	Retail price
26 Chrome	<b>A</b>	320 mm [12.5/8"]	310497	\$ 39.70
15 Satin nickel	<b>A</b>	320 mm [12.5/8"]	310541	\$ 40.90
26 Chrome	<b>B</b>	160 mm [6.5/16"]	310503	\$ 27.70
15 Satin nickel	<b>B</b>	160 mm [6.5/16"]	310534	\$ 28.60
26 Chrome	<b>C</b>	128 mm [5"]	310510	\$ 18.40
15 Satin nickel	<b>C</b>	128 mm [5"]	310527	\$ 19.00

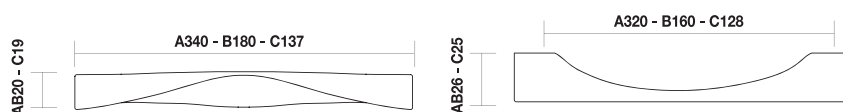

# A 2061

design Valli Workshop

**Nikrall Zamak Alloy UNI 3717**  
Nikrall Lega Zama UNI 3717

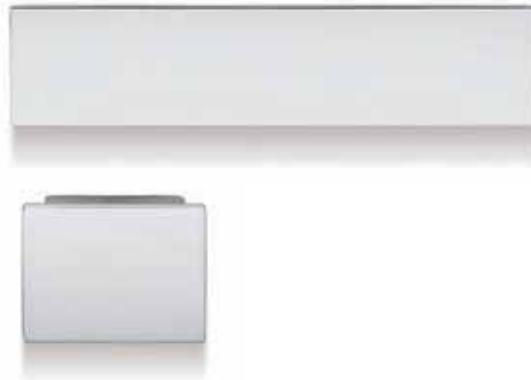

Finish	Size	Center to center <sup>↕↔</sup>	Bar code	Retail price
26 Chrome	<b>A</b>	320 mm [12.5/8"]	310695	\$ 46.80
15 Satin nickel	<b>A</b>	320 mm [12.5/8"]	310763	\$ 49.60
26 Chrome	<b>B</b>	192 mm [7.9/16"]	310701	\$ 34.10
15 Satin nickel	<b>B</b>	192 mm [7.9/16"]	310756	\$ 35.70
26 Chrome	<b>C</b>	160 mm [6.5/16"]	310718	\$ 29.80
15 Satin nickel	<b>C</b>	160 mm [6.5/16"]	310749	\$ 31.10
26 Chrome	<b>D</b>	16 mm [5/8"]	310725	\$ 11.90
15 Satin nickel	<b>D</b>	16 mm [5/8"]	310732	\$ 12.50

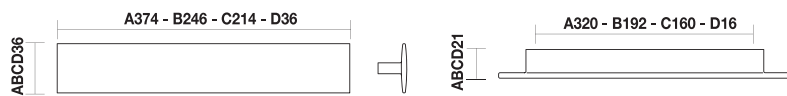

# A 2062

design Valli Workshop

**Nikrall Zamak Alloy UNI 3717**  
Nikrall Lega Zama UNI 3717



Finish	Size	Center to center <sup>✧✧</sup>	Bar code	Retail price
26 Chrome	<b>A</b>	320 mm [12.5/8"]	310770	\$ 34.10
15 Satin nickel	<b>A</b>	320 mm [12.5/8"]	310848	\$ 35.40
26 Chrome	<b>B</b>	192 mm [7.9/16"]	310787	\$ 24.90
15 Satin nickel	<b>B</b>	192 mm [7.9/16"]	310831	\$ 26.10
26 Chrome	<b>C</b>	160 mm [6.5/16"]	310794	\$ 23.30
15 Satin nickel	<b>C</b>	160 mm [6.5/16"]	310824	\$ 24.30
26 Chrome	<b>D</b>	128 mm [5"]	310800	\$ 19.90
15 Satin nickel	<b>D</b>	128 mm [5"]	310817	\$ 20.50



# A 2068

design Michel Boucquillon

**Nikrall Zamak Alloy UNI 3717**  
Nikrall Lega Zama UNI 3717



Finish	Size	Center to center	Bar code	Retail price
26 Chrome	<b>A</b>	320 mm [12.5/8"]	311012	\$ 50.60
15 Satin nickel	<b>A</b>	320 mm [12.5/8"]	311081	\$ 53.00
26 Chrome	<b>B</b>	192 mm [7.9/16"]	311029	\$ 34.80
15 Satin nickel	<b>B</b>	192 mm [7.9/16"]	311074	\$ 36.60
26 Chrome	<b>C</b>	160 mm [6.5/16"]	311036	\$ 28.90
15 Satin nickel	<b>C</b>	160 mm [6.5/16"]	311067	\$ 30.40
26 Chrome	<b>D</b>	96 mm [3.3/4"]	311043	\$ 21.80
15 Satin nickel	<b>D</b>	96 mm [3.3/4"]	311050	\$ 22.70

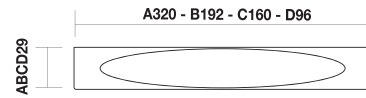
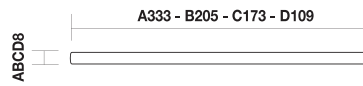

# Y 2278

Counter top display

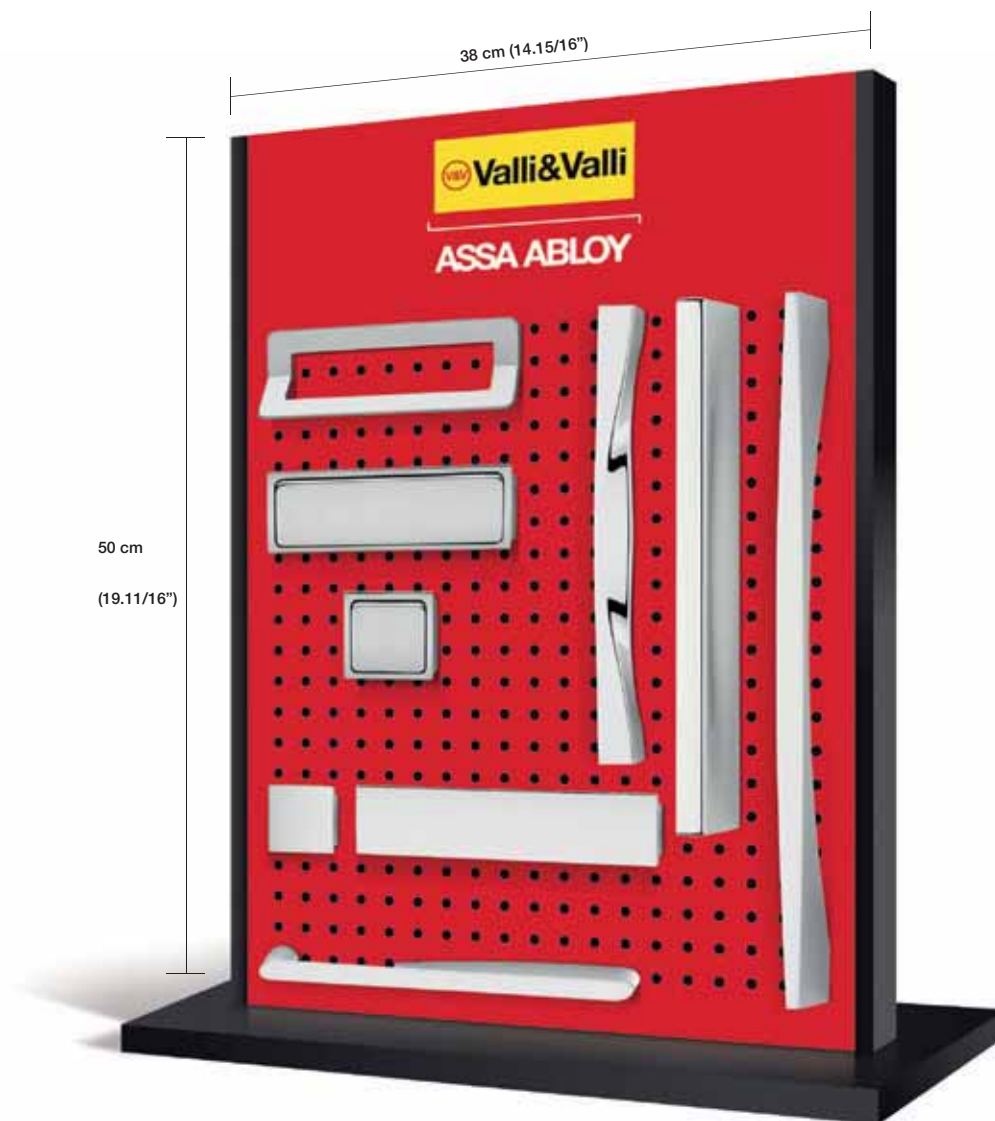

**Features:**

- Frame structure in bent and welded metal
- Two-sided boards in semi-expanded red pvc, with 16 mm distanced horizontal and vertical holes
- Packaged in a box with mounting instructions inside









Cabinet  
knobs/Pomoli

## B 33

design Gregotti Associati



Brass  
Ottone

Finish	Size	Diameter $\varnothing$	Bar code	Retail price
 26 Chrome	<b>B</b>	16 mm [5/8"]	400853	\$ 20.20
 26D Satin chrome	<b>B</b>	16 mm [5/8"]	423968	\$ 19.60
 03 Brass	<b>B</b>	16 mm [5/8"]	400891	\$ 22.50
 26 Chrome	<b>C</b>	12 mm [7/16"]	400860	\$ 16.20
 26D Satin chrome	<b>C</b>	12 mm [7/16"]	423975	\$ 17.90
 03 Brass	<b>C</b>	12 mm [7/16"]	400907	\$ 16.90

B16 - C12



B30 - C25

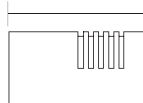



## B 120

design Valli Workshop



Brass  
Ottone

Finish	Size	Diameter $\varnothing$	Bar code	Retail price
 03 Brass	<b>B</b>	30 mm [1.3/16"]	003306	\$ 17.90
 03 Brass	<b>C</b>	25 mm [1"]	003313	\$ 16.20

B30 - C25

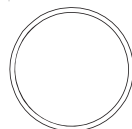

B23 - C21



# B 128

design Valli Workshop



**Brass**  
Ottone



Finish	Size	Diameter $\phi$	Bar code	Retail price
22 White	<b>B</b>	18 mm [11/16"]	003702	\$ 6.10
03 Brass	<b>B</b>	18 mm [11/16"]	003689	\$ 7.40
06 Antique brass	<b>B</b>	18 mm [11/16"]	003665	\$ 7.40
22 White	<b>C</b>	13 mm [1/2"]	003719	\$ 5.80
03 Brass	<b>C</b>	13 mm [1/2"]	003696	\$ 6.80
06 Antique brass	<b>C</b>	13 mm [1/2"]	003672	\$ 6.80

B18 - C13



B24 - C23

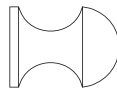

# B 237

design Valli Workshop



**Porcelain and Brass**  
Porcellana e Ottone



Finish	Size	Diameter $\phi$	Bar code	Retail price
22 White	<b>A</b>	35 mm [1.3/8"]	605160	\$ 16.00
Floral	<b>A</b>	35 mm [1.3/8"]	605221	\$ 21.00
22 White	<b>B</b>	30 mm [1.3/16"]	605177	\$ 15.20
Floral	<b>B</b>	30 mm [1.3/16"]	605238	\$ 20.10
22 White	<b>C</b>	25 mm [1"]	605184	\$ 15.00
Floral	<b>C</b>	25 mm [1"]	605245	\$ 19.40

A35 - B30 - C25

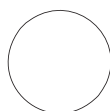

A30 - B28 - C25

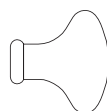

# B 239

design Gost&Schreyer



**Brass**  
Ottone



Finish	Size	Diameter $\varnothing$	Bar code	Retail price
26 Chrome	<b>C</b>	13 mm [1/2"]	631336	\$ 8.70
15 Satin nickel	<b>C</b>	13 mm [1/2"]	631329	\$ 8.70



# B 242

design Eero Aarnio

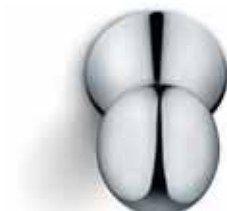

**Brass**  
Ottone



Finish	Size	Diameter $\varnothing$	Bar code	Retail price
26 Chrome	<b>C</b>	14 mm [11/16"]	631497	\$ 9.20
15 Satin nickel	<b>C</b>	14 mm [11/16"]	631480	\$ 9.90
03 Polished brass	<b>C</b>	14 mm [11/16"]	633583	\$ 9.20

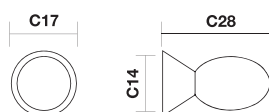

# B 985

design Valli Workshop



**Nikrall Zamak Alloy UNI 3717  
and Wrought iron**  
Nikrall Lega Zama UNI 3717  
e Ferro battuto



Finish	Size	Diameter $\phi$	Bar code	Retail price
Iron	<b>B</b>	30 mm [1.3/16"]	603500	\$ 6.50
Iron	<b>C</b>	25 mm [1"]	603517	\$ 6.50

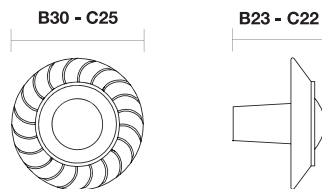

# B 985 PL

design Valli Workshop



**Iron**  
Ferro



Finish	Size	Dimension	Bar code	Retail price
Iron	<b>B</b>	93 mm [3.5/8"]	603531	\$ 5.00
Iron	<b>C</b>	76 mm [3"]	603548	\$ 5.00

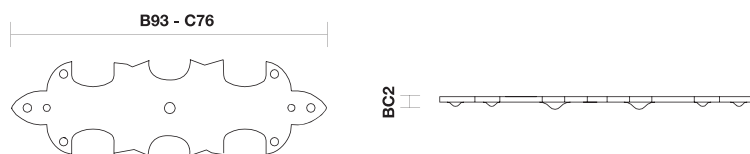



Mortise locks

# Rosette options

## KEYED CYLINDER

RP Plain Rosette with cylinder collar  
mm 65 (2.9/16")



(shown w/H 38 Door lever)

RPS Plain Rosette Stainless steel with cylinder collar  
mm 65 (2.9/16")



(shown w/H 5004 Door lever)

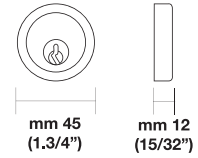

## THUMBTURN INTERIOR/EMERGENCY RELEASE PRIVACY

RP Plain Rosette mm 65 (2.9/16")  
Thumbturn (Interior)



(shown w/H 326 Door lever)

Emergency Release (Privacy)

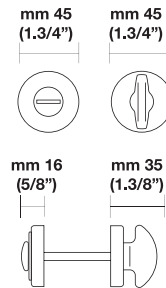

RQ Square Rosette mm 65 (2.9/16")  
Thumbturn (Interior)



(shown w/H 311 Door lever)

Emergency Release (Privacy)

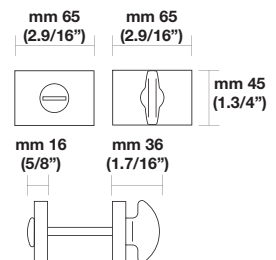

RT Traditional Rosette mm 65 (2.9/16")  
Thumbturn (Interior)



(shown w/H 1004 Door lever)

Emergency Release (Privacy)

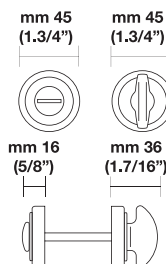



# Rosette options

## THUMBTURN INTERIOR/EMERGENCY RELEASE PRIVACY

RPS Plain Rosette Stainless steel mm 65 (2.9/16")

Thumbturn (Interior)

Emergency Release (Privacy)

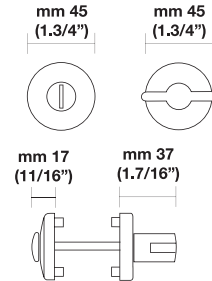

(shown w/H 5004 Door lever)

RQS Rectangular Rosette Stainless steel mm 65 (2.9/16")

Thumbturn (Interior)

Emergency Release (Privacy)

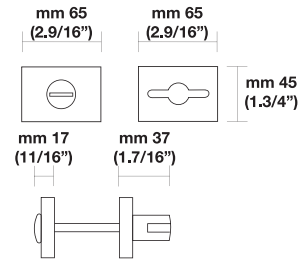

(shown w/H 5008 Door lever)

# Escutcheon plate options

## KEYED CYLINDER

ER/ERS Rectangular Escutcheon

ET Traditional Escutcheon

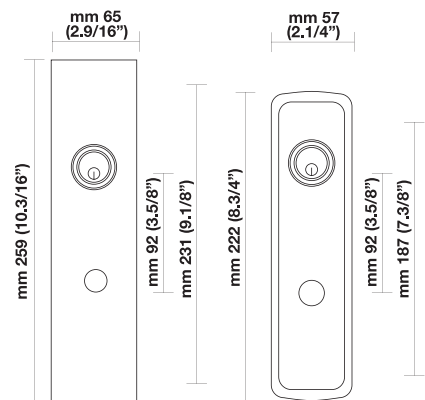

(shown w/H 311 Door lever)

(shown w/H 179 Door lever)

# Escutcheon plate options

## KEYED CYLINDER

EP Plain Escutcheon



(shown w/H 38 Door lever)

NES Narrow Plain Escutcheon Stainless steel



(shown w/H 5004 Door lever)

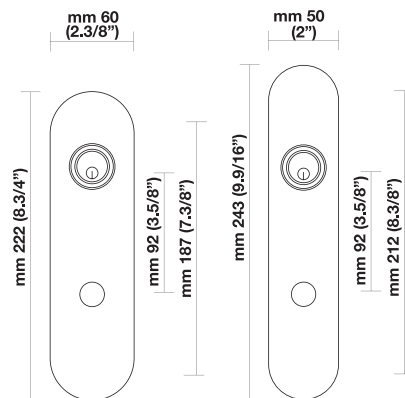

## THUMBTURN INTERIOR/EMERGENCY RELEASE PRIVACY

Thumbturn (Interior)  
ER/ERS Rectangular Escutcheon



(shown w/H 311 Door lever)

Stainless steel  
NES Narrow Plain Escutcheon



(shown w/H 5004 Door lever)

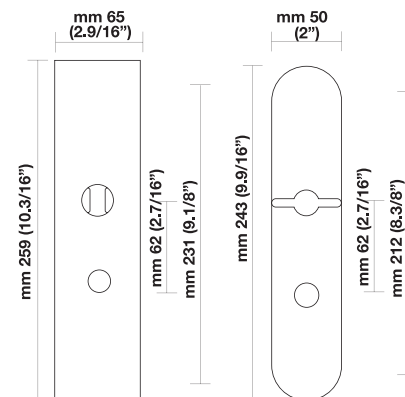

Emergency Release (Privacy)  
ER/ERS Rectangular Escutcheon



(shown w/H 311 Door lever)

EP Plain Escutcheon



(shown w/H 38 Door lever)

ET Traditional Escutcheon



(shown w/H 179 Door lever)

# V&V Group I - Mortise locks

Material: solid brass

DOOR LEVERS	H 163, H 192, H 195, H 198, H 1003, H 1004, H 1012, H 1017, H 1022, H 1024, H 1034*, H 1037, H 1038, H1050, K1168					Retail Price
	RP/RT	RQ	RS	EP/ET	ER	
ML F/Entrance	\$ 759.00	\$ 830.00	\$ 630.00	\$ 670.00	\$ 699.00	\$ 699.00
ML FD/Entrance	\$ 799.00	\$ 870.00	\$ 670.00	\$ 710.00	\$ 740.00	\$ 740.00
ML FW/Entrance	\$ 740.00	\$ 810.00	\$ 598.00	\$ 650.00	\$ 674.00	\$ 674.00
ML B/Entrance	\$ 768.00	\$ 834.00	\$ 627.00	\$ 648.00	\$ 698.00	\$ 698.00
ML E/Office	\$ 715.00	\$ 735.00	\$ 580.00	\$ 670.00	\$ 710.00	\$ 710.00
ML EW/Storeroom	\$ 680.00	\$ 699.00	\$ 550.00	\$ 640.00	\$ 675.00	\$ 675.00
ML J/Classroom	\$ 715.00	\$ 735.00	\$ 580.00	\$ 670.00	\$ 710.00	\$ 710.00
ML N/Passage	\$ 590.00	\$ 570.00	\$ 449.00	\$ 565.00	\$ 595.00	\$ 595.00
ML LF/Privacy	\$ 760.00	\$ 830.00	\$ 630.00	\$ 630.00	\$ 665.00	\$ 665.00
ML AC/Entrance	\$ 752.00	\$ 797.00	\$ 617.00	\$ 694.00	\$ 726.00	\$ 726.00
ML H/Hotel	-	-	-	\$ 630.00	\$ 699.00	\$ 699.00
ML NC/Communicating	\$ 395.00	\$ 405.00	\$ 405.00	\$ 455.00	\$ 475.00	\$ 475.00
ML ELEC/Electrified	\$ 1,647.00	\$ 1,735.00	\$ 1,514.00	\$ 1,607.00	\$ 1,642.00	\$ 1,642.00

Series Group I	Finish options (see note per RQ-EP-ER)					
H 163	03	06B	26	26D		
H 192	15					
H 195	26D					
H 198	03	03D	06A	14	15	26D
H 1003	03	03D	06A	14	15	26D
H 1004	06B					
H 1012	26D					
H 1017	26D					
H 1022	03/03D	26/26D				
H 1024	03	26	26D			
H 1034*	26	26D				
H 1037	03	14	15			
H 1038	14	15	17/03D	26/26D	26D	
H 1050	26	26D				
K 1168	26	26D				

Narrow backset mortise lock, see page 185, call factory for pricing.

#### NOTE

All levers are stocked in finishes indicated.

ET/EP = 03-26 Standard Finish ER = 15-26-26D Standard Finish RQ = 14-15-26-26D Standard Finish

Standard Bolt Finish = 03D/Satin Brass, 26D/Satin Chrome.

**RS/RSQ = Trim not recommended for commercial use.**

Without cylinder deduct \$ 15.00 retail price.

H 1034 not available with long escutcheon plate.

# V&V Group II - Mortise locks

Material: solid brass

	Retail Price				
	RP/RT	RQ	RS	EP/ET	ER
<b>DOOR LEVERS</b>	H 165, H 174, H 176, H 179, H 1015, H 1016, H 1018, H 1026, H 1027, H 1045, H 1046, H 1049, H 1051				
<b>ML F/Entrance</b>	\$ 820.00	\$ 880.00	\$ 690.00	\$ 725.00	\$ 760.00
<b>ML FD/Entrance</b>	\$ 855.00	\$ 920.00	\$ 725.00	\$ 765.00	\$ 795.00
<b>ML FW/Entrance</b>	\$ 803.00	\$ 865.00	\$ 661.00	\$ 707.00	\$ 736.00
<b>ML B/Entrance</b>	\$ 828.00	\$ 893.00	\$ 685.00	\$ 707.00	\$ 757.00
<b>ML E/Office</b>	\$ 770.00	\$ 790.00	\$ 640.00	\$ 730.00	\$ 770.00
<b>ML EW/Storeroom</b>	\$ 740.00	\$ 760.00	\$ 610.00	\$ 695.00	\$ 735.00
<b>ML J/Classroom</b>	\$ 770.00	\$ 790.00	\$ 640.00	\$ 730.00	\$ 770.00
<b>ML N/Passage</b>	\$ 645.00	\$ 625.00	\$ 504.00	\$ 620.00	\$ 650.00
<b>ML LF/Privacy</b>	\$ 814.00	\$ 890.00	\$ 690.00	\$ 690.00	\$ 720.00
<b>ML AC/Entrance</b>	\$ 813.00	\$ 858.00	\$ 678.00	\$ 755.00	\$ 785.00
<b>ML H/Hotel</b>	-	-	-	\$ 690.00	\$ 755.00
<b>ML NC/Communicating</b>	\$ 426.00	\$ 431.00	\$ 433.00	\$ 484.00	\$ 500.00
<b>ML ELEC/Electrified</b>	\$ 1,761.00	\$ 1,853.00	\$ 1,617.00	\$ 1,715.00	\$ 1,753.00

**Series Group II** **Finish options (see note per RQ-EP-ER)**

<b>H 165</b>	03	03D	06A	
<b>H 174</b>	03			
<b>H 176</b>	03/22			
<b>H 179</b>	03			
<b>H 1015</b>	03/03D	26/26D		
<b>H 1016</b>	06A	14	15	26D
<b>H 1018</b>	26/26D			
<b>H 1026</b>	03D/03	26D/26		
<b>H 1027</b>	03	26D		
<b>H 1045</b>	14	15	26	26D/26
<b>H 1046</b>	14	15	26	26D
<b>H 1049</b>	26	26D		
<b>H 1051</b>	26	26D		

**Narrow backset mortise lock, see page 185, call factory for pricing.**

**NOTE**

All levers are stocked in finishes indicated.

ET/EP = 03-26 Standard Finish ER = 15-26-26D Standard Finish RQ = 14-15-26-26D Standard Finish

Standard Bolt Finish = 03D/Satin Brass, 26D/Satin Chrome.

**RS/RSQ = Trim not recommended for commercial use.**

Without cylinder deduct \$15.00 retail price.

# V&V Group III - Mortise locks

Material: solid brass

## DOOR LEVERS

H 1039, H 1042

					Retail Price
	RP/RT	RQ	RS	EP/ET	ER
<b>ML F/Entrance</b>	\$ 956.00	\$ 1,025.00	\$ 821.00	\$ 860.00	\$ 890.00
<b>ML FD/Entrance</b>	\$ 999.00	\$ 1,060.00	\$ 860.00	\$ 905.00	\$ 930.00
<b>ML FW/Entrance</b>	\$ 948.00	\$ 1,011.00	\$ 803.00	\$ 850.00	\$ 881.00
<b>ML B/Entrance</b>	\$ 968.00	\$ 1,029.00	\$ 824.00	\$ 845.00	\$ 896.00
<b>ML E/Office</b>	\$ 906.00	\$ 929.00	\$ 780.00	\$ 865.00	\$ 902.00
<b>ML EW/Storeroom</b>	\$ 875.00	\$ 899.00	\$ 745.00	\$ 835.00	\$ 870.00
<b>ML J/Classroom</b>	\$ 906.00	\$ 929.00	\$ 780.00	\$ 865.00	\$ 902.00
<b>ML N/Passage</b>	\$ 787.00	\$ 767.00	\$ 655.00	\$ 762.00	\$ 793.00
<b>ML LF/Privacy</b>	\$ 963.00	\$ 1,029.00	\$ 829.00	\$ 829.00	\$ 865.00
<b>ML AC/Entrance</b>	\$ 963.00	\$ 1,009.00	\$ 829.00	\$ 906.00	\$ 935.00
<b>ML H/Hotel</b>	-	-	-	\$ 825.00	\$ 899.00
<b>ML NC/Communicating</b>	\$ 494.00	\$ 501.00	\$ 506.00	\$ 556.00	\$ 572.00
<b>ML ELEC/Electrified</b>	\$ 1,853.00	\$ 1,936.00	\$ 1,714.00	\$ 1,821.00	\$ 1,854.00

## Series Group III

Finish options (see note per RQ-EP-ER)

<b>H 1039</b>	14	15	26/26D	
<b>H 1042</b>	14	15	26	26D

## Narrow backset mortise lock available/Detail page 185

1.1/2"-1.3/4"-2"-2.1/4" Backset

### Solid Brass

#### How to order

#### Call factory for pricing

ML F Narrow RP 15  
ML FW Narrow RP 15  
ML EW Narrow RP 15  
ML E Narrow RP 15  
ML J Narrow RP 15  
ML N Narrow RP 15  
ML LF Narrow RP 15

(Other finishes available on request)

RQS, RQ Square Rosette = Not Available

### Stainless Steel

#### How to order

#### Call factory for pricing

ML F Narrow RPS 32D  
ML FW Narrow RPS 32D  
ML EW Narrow RPS 32D  
ML E Narrow RPS 32D  
ML J Narrow RPS 32D  
ML N Narrow RPS 32D  
ML LF Narrow RPS 32D

## NOTE

All levers are stocked in finishes indicated.

ET/EP = 03-26 Standard Finish ER = 15-26-26D Standard Finish RQ = 14-15-26-26D Standard Finish

Standard Bolt Finish = 03D/Satin Brass, 26D/Satin Chrome.

**RS/RSQ = Trim not recommended for commercial use.**

Without cylinder deduct \$15.00 retail price.

# V&V Group IV - Mortise locks

Material: solid brass, nikrall zamak alloy uni 1317

**DOOR LEVERS** H 412, H 417, H 421, H 1043, H 1044, H 4705, H 4707, H 4730, H 4734, H 4742, H 4744, K 4712, K 4714

	Retail Price				
	RP/RT	RQ	RS	ET/EP	ER
<b>ML F/Entrance</b>	\$ 734.00	\$ 798.00	\$ 599.00	\$ 640.00	\$ 670.00
<b>ML FD/Entrance</b>	\$ 771.00	\$ 840.00	\$ 639.00	\$ 679.00	\$ 710.00
<b>ML FW/Entrance</b>	\$ 719.00	\$ 782.00	\$ 578.00	\$ 623.00	\$ 653.00
<b>ML B/Entrance</b>	\$ 736.00	\$ 801.00	\$ 597.00	\$ 617.00	\$ 667.00
<b>ML E/Office</b>	\$ 685.00	\$ 706.00	\$ 559.00	\$ 643.00	\$ 680.00
<b>ML EW/Storeroom</b>	\$ 651.00	\$ 672.00	\$ 520.00	\$ 610.00	\$ 647.00
<b>ML J/Classroom</b>	\$ 685.00	\$ 706.00	\$ 559.00	\$ 643.00	\$ 680.00
<b>ML N/Passage</b>	\$ 545.00	\$ 548.00	\$ 540.00	\$ 570.00	\$ 735.00
<b>ML LF/Privacy</b>	\$ 733.00	\$ 810.00	\$ 605.00	\$ 600.00	\$ 637.00
<b>ML AC/Entrance</b>	\$ 727.00	\$ 773.00	\$ 592.00	\$ 667.00	\$ 699.00
<b>ML H/Hotel</b>	-	-	-	\$ 610.00	\$ 680.00
<b>ML NC/Communicating</b>	\$ 385.00	\$ 388.00	\$ 390.00	\$ 445.00	\$ 460.00
<b>ML ELEC/Electrified</b>	\$ 1,620.00	\$ 1,689.00	\$ 1,490.00	\$ 1,580.00	\$ 1,620.00

**Series Group IV** **Finish options (see note per RQ-EP-ER)**

<b>H 412</b>	26D			
<b>H 417</b>	26D			
<b>H 421</b>	26	26D		
<b>H 1043</b>	15	26/26D		
<b>H 1044</b>	14	15	26	26D
<b>H 4705</b>	26/32D			
<b>H 4707</b>	26D			
<b>H 4730</b>	26/26D			
<b>H 4734</b>	26/32D			
<b>H 4742</b>	26/32D			
<b>H 4744</b>	26/32D			
<b>K 4712</b>	03	06B	26	26D
<b>K 4714</b>	03	06B	26	26D

**Narrow backset mortise lock, see page 185, call factory for pricing.**

**NOTE**

All levers are stocked in finishes indicated.

ET/EP = 03-26 Standard Finish ER = 15-26-26D Standard Finish RQ = 14-15-26-26D Standard Finish

Standard Bolt Finish = 03D/Satin Brass, 26D/Satin Chrome.

**RS/RSQ = Trim not recommended for commercial use.**

Without cylinder deduct \$15.00 retail price.

# V&V Inox - Mortise locks

Material: stainless steel AISI 304

## V&V INOX

H 414, H 415, H 416, H 419  
32D=Satin stainless steel finish only.

	Retail Price				
	RPS	RQS	RSS	NES	ERS
<b>ML F/Entrance</b>	\$ 926.00	\$ 901.00	\$ 686.00	\$ 718.00	\$ 747.00
<b>ML FD/Entrance</b>	\$ 960.00	\$ 935.00	\$ 720.00	\$ 750.00	\$ 780.00
<b>ML FW/Entrance</b>	\$ 906.00	\$ 881.00	\$ 661.00	\$ 695.00	\$ 726.00
<b>ML B/Entrance</b>	\$ 927.00	\$ 904.00	\$ 678.00	\$ 711.00	\$ 742.00
<b>ML E/Office</b>	\$ 797.00	\$ 763.00	\$ 554.00	\$ 676.00	\$ 756.00
<b>ML EW/Storeroom</b>	\$ 763.00	\$ 730.00	\$ 521.00	\$ 643.00	\$ 723.00
<b>ML J/Classroom</b>	\$ 797.00	\$ 763.00	\$ 554.00	\$ 676.00	\$ 756.00
<b>ML N/Passage</b>	\$ 628.00	\$ 575.00	\$ 386.00	\$ 544.00	\$ 623.00
<b>ML LF/Privacy</b>	\$ 922.00	\$ 886.00	\$ 678.00	\$ 640.00	\$ 689.00
<b>ML AC/Entrance</b>	\$ 886.00	\$ 829.00	\$ 628.00	\$ 736.00	\$ 793.00
<b>ML H/Hotel</b>	-	-	-	\$ 770.00	\$ 730.00
<b>ML NC/Communicating</b>	\$ 431.00	\$ 404.00	\$ 417.00	\$ 438.00	\$ 494.00
<b>ML ELEC/Electrified</b>	\$ 1,746.00	\$ 1,818.00	\$ 1,500.00	\$ 1,625.00	\$ 1,703.00

## Deadlock

Cylinder not included/  
specify backset

finish options 03 - 15 - 26 - 26D - 32D

	Retail Price					
	Rosette Finish	RT/RP 26	RT/RP 26D	RT/RP 03	RT/RP 15	RPS 32D
<b>ML - Deadlock</b>	Complete	\$ 310.00	\$ 325.00	\$ 320.00	\$ 330.00	\$ 430.00
<b>ML - Deadlock</b>	Trim only	\$ 138.00	\$ 153.00	\$ 148.00	\$ 156.00	\$ 258.00

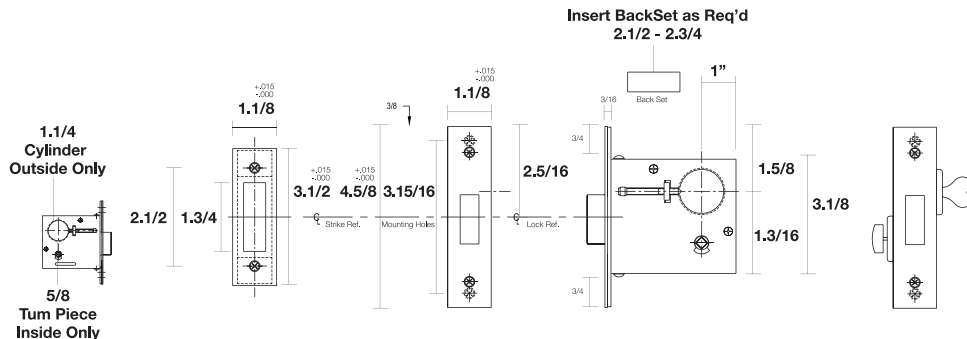

Narrow backset mortise lock, see page 185, call factory for pricing.

## NOTE

RPS, RQS, RSS, NES, ERS: 32D standard finish available.

32/Polish add \$ 250.00 retail price to 32D/Satin finish. Minimum quantity applied.

RSS: trim not recommended for commercial use.

Without cylinder deduct \$ 15.00 retail price.

Deadbolts/  
Privacy Bolts



# Deadbolts

**101 RP Plain**  
Solid brass



**101 RQ Square**  
Solid brass



**101 RT Traditional**  
Solid brass



**101 SINGLE CYLINDER**

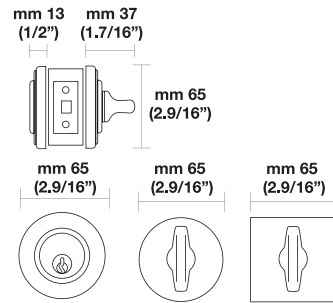

**101 RPS Plain**  
Stainless steel AISI 316 L



**101 RQS Square**  
Stainless steel AISI 316 L



**102 DOUBLE CYLINDER**

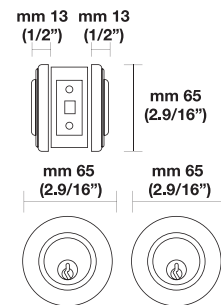

**101 RQ / K1225**  
Solid brass

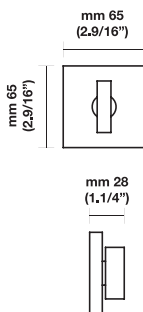

Call factory for pricing

# Privacy bolts

**105 RSP Plain**  
Solid brass



**105 RSQ Square**  
Solid brass



**105 RST Traditional**  
Solid brass



**105 PRIVACY BOLT**  
Solid Brass

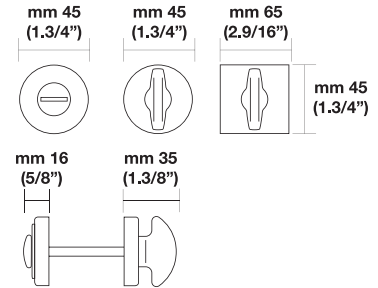

**105 RSS Plain**  
Stainless steel AISI 316 L



**105 RSQS Square**  
Stainless steel AISI 316 L



**105 PRIVACY BOLT**  
Stainless steel AISI 316 L

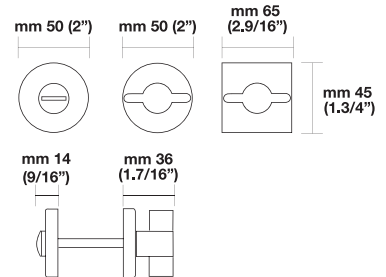

**K 1225 RSQ (2 x 2")**  
Solid brass

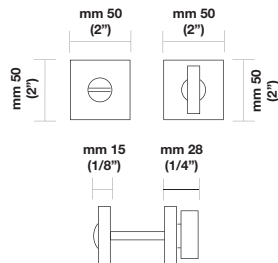

**105 RSQ / K1225 (2.9/16" x 1.3/4")**  
Solid brass

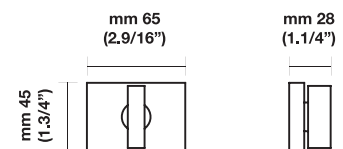

Call factory for pricing

# Deadbolts/Privacy bolts

Material: solid brass, stainless steel 316 L

## 101 SINGLE CYLINDER DEADBOLT

Retail Price



Finish	RT	RP	RQ	RPS	RQS
03	-	\$ 266.00	-	-	-
03D	-	\$ 269.00	-	-	-
03/03D	\$ 240.00	-	-	-	-
06A	\$ 263.00	\$ 273.00	-	-	-
06B	\$ 251.00	\$ 259.00	-	-	-
14	\$ 264.00	\$ 265.00	\$ 358.00	-	-
15	\$ 261.00	\$ 264.00	\$ 364.00	-	-
26	-	\$ 253.00	\$ 338.00	-	-
26D	-	\$ 254.00	\$ 354.00	-	-
26/26D	\$ 250.00	-	-	-	-
32	-	-	-	\$ 496.00	\$ 519.00
32D	-	-	-	\$ 414.00	\$ 426.00

## 101 SINGLE CYLINDER DEADBOLT/LESS EXTERIOR TRIM

Retail Price



Finish	RT/LE	RP/LE	RQ/LE	RPS/LE	RQS/LE
03	-	\$ 197.00	-	-	-
03D	-	\$ 197.00	-	-	-
03/03D	\$ 175.00	-	-	-	-
06A	\$ 198.00	\$ 201.00	-	-	-
06B	\$ 179.00	\$ 179.00	-	-	-
14	\$ 193.00	\$ 191.00	\$ 231.00	-	-
15	\$ 182.00	\$ 181.00	\$ 222.00	-	-
26	-	\$ 184.00	\$ 218.00	-	-
26D	-	\$ 181.00	\$ 222.00	-	-
26/26D	\$ 184.00	-	-	-	-
32	-	-	-	\$ 325.00	\$ 308.00
32D	-	-	-	\$ 270.00	\$ 247.00

## K1125 PRIVACY BOLT 2" X 2"

Retail Price



Finish	RSQ				
14	\$ 370.00	-	-	-	-
15	\$ 340.00	-	-	-	-
26	\$ 310.00	-	-	-	-
26D	\$ 340.00	-	-	-	-

**102 DOUBLE CYLINDER DEADBOLT**

Finish	RT	RP	RQ	RPS	Retail Price
					RQS
03	-	\$ 256.00	-	-	-
03D	-	\$ 263.00	-	-	-
03/03D	\$ 249.00	-	-	-	-
06A	\$ 251.00	\$ 268.00	-	-	-
06B	\$ 268.00	\$ 283.00	-	-	-
14	\$ 270.00	\$ 278.00	\$ 340.00	-	-
15	\$ 278.00	\$ 284.00	\$ 361.00	-	-
26	-	\$ 268.00	\$ 324.00	-	-
26D	-	\$ 266.00	\$ 342.00	-	-
26/26D	\$ 260.00	-	-	-	-
32	-	-	-	\$ 479.00	\$ 517.00
32D	-	-	-	\$ 414.00	\$ 444.00

**105 PRIVACY BOLTS**

Finish	RST	RSP	RSQ	RSS	Retail Price
					RSQS
03	-	\$ 212.00	-	-	-
03D	-	\$ 212.00	-	-	-
03/03D	\$ 229.00	-	-	-	-
06A	\$ 280.00	\$ 235.00	-	-	-
14	\$ 262.00	\$ 251.00	\$ 363.00	-	-
15	\$ 249.00	\$ 242.00	\$ 331.00	-	-
26	-	\$ 214.00	\$ 304.00	-	-
26D	-	\$ 242.00	\$ 331.00	-	-
26/26D	\$ 277.00	-	-	-	-
32	-	-	-	\$ 192.00	\$ 436.00
32D	-	-	-	\$ 161.00	\$ 350.00

**105 PRIVACY BOLT/LESS EXTERIOR TRIM**

Finish	RST/LE	RSP/LE	RSQ/LE	RSS/LE	Retail Price
					RSQS/LE
03	-	\$ 135.00	-	-	-
03D	-	\$ 135.00	-	-	-
03/03D	\$ 143.00	-	-	-	-
06A	\$ 168.00	\$ 158.00	-	-	-
14	\$ 156.00	\$ 156.00	\$ 208.00	-	-
15	\$ 151.00	\$ 151.00	\$ 193.00	-	-
26	-	\$ 137.00	\$ 178.00	-	-
26D	-	\$ 151.00	\$ 193.00	-	-
26/26D	\$ 167.00	-	-	-	-
32	-	-	-	\$ 239.00	\$ 277.00
32D	-	-	-	\$ 219.00	\$ 230.00

Escutcheons  
with deadbolts

# V&V/Escutcheon with deadbolts

Material: solid brass

ER - 103 Rectangular Escutcheon (shown w/H 311 Door lever)

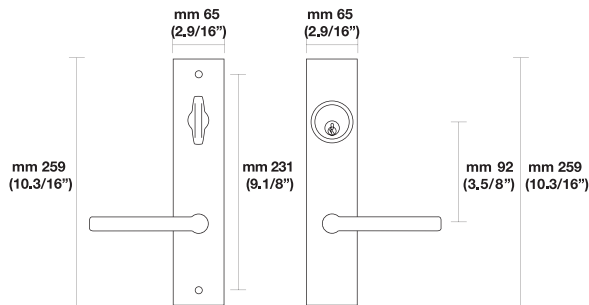
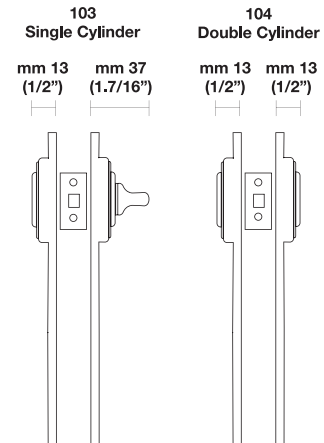

# V&V Inox/Escutcheon with deadbolts

Material: stainless steel AISI 316 L

ERS - 103 Rectangular Escutcheon Stainless steel (shown w/H 5004 Door lever)

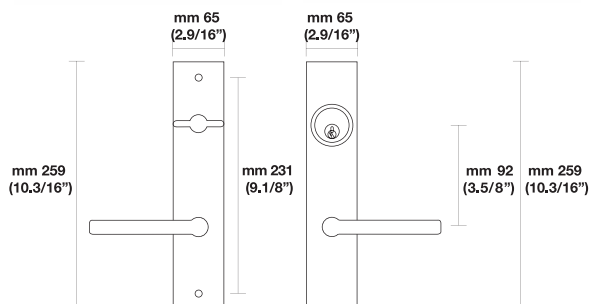
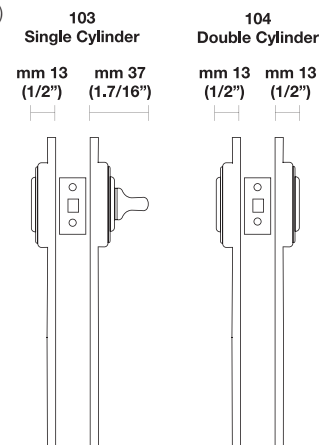

# V&V Escutcheon with deadbolt

Material: solid brass

GROUP I	H 163, H 192, H 195, H 198, H 1003, H 1004, H 1012, H 1017, H 1022, H 1024, H 1037, H 1038, H 1050, K 1168		
	Retail Price		
	103	104	106
<b>EP/ET</b>	\$ 548.00	\$ 536.00	\$ 500.00
<b>ER</b>	\$ 585.00	\$ 573.00	\$ 546.00

GROUP II	H 165, H 174, H 176, H 179, H 1015, H 1016, H 1018, H 1026, H 1027, H 1045, H 1046, H 1049, H 1051		
	Retail Price		
	103	104	106
<b>EP/ET</b>	\$ 594.00	\$ 582.00	\$ 548.00
<b>ER</b>	\$ 643.00	\$ 632.00	\$ 607.00

GROUP III	H 1039, H 1042		
	Retail Price		
	103	104	106
<b>EP/ET</b>	\$ 759.00	\$ 747.00	\$ 711.00
<b>ER</b>	\$ 795.00	\$ 783.00	\$ 757.00

GROUP IV	H 412, H 417, H 421, H 1043, H 1044, H 4705, H 4707, H 4730, H 4734, H 4742, H 4744		
	Retail Price		
	103	104	106
<b>EP/ET</b>	\$ 514.00	\$ 504.00	\$ 469.00
<b>ER</b>	\$ 546.00	\$ 536.00	\$ 510.00

# V&V Inox

Material: stainless steel AISI 304

DOOR LEVERS	H 414, H 415, H 416, H 419		
	Retail Price		
	103	104	106
<b>ERS</b>	\$ 605.00	\$ 616.00	\$ 544.00

**NOTE**

**103** Escutcheon Single Cylinder

**104** Escutcheon Double Cylinder

**106** Escutcheon Privacy Bolt

EP/ET= 03-26 Standard finish

ER= 15-26-26D Standard finish

ERS= available only in 32D finish





# Multi-Point Trims

# Functions

Multi-Point Trim

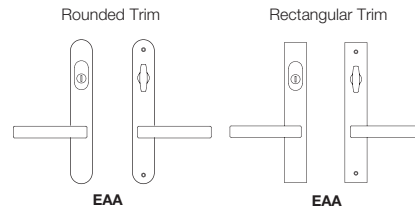

### EAA Entry Set-Key above

Entry function with American cylinder above the lever, 92mm center to center.

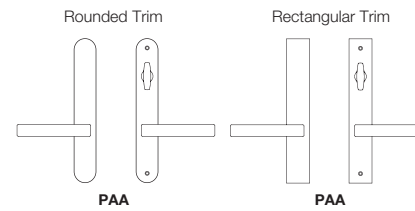

### PAA Patio Set-No keyway

Patio function with the interior thumbturn above the lever, no keyway on the exterior plate.

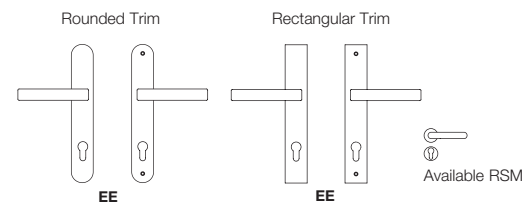

### EE Entry Set-With profile cylinder

Entry function with profile cylinder 92mm center to center.

# Functions

Multi-Point Trim

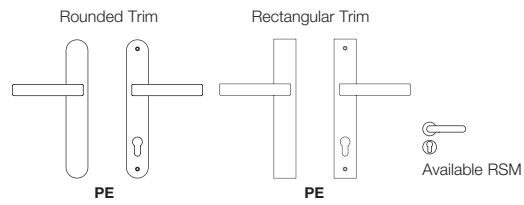

**PE Patio Set-Profile cylinder no key**  
Patio function with 1/2 profile cylinder and thumbturn, no keyway on the exterior plate.

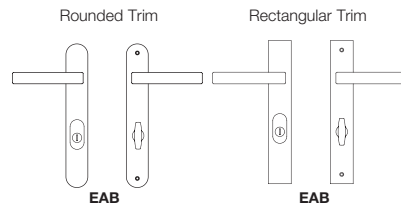

**EAB Entry Set-Key below**  
Entry function with American cylinder below the lever, 92mm center to center.

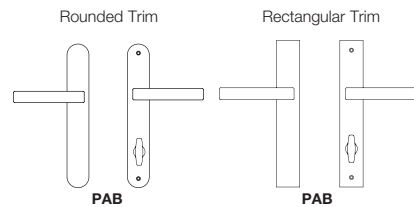

**PAB Patio Set-No keyway**  
Patio function with the interior thumbturn below the lever, no keyway on the exterior plate.

**CE Entry Set-Custom**  
Custom entry function with special center to center sizes. Uses a profile cylinder.

**DA Active Dummy**  
Active dummy pair.

# Functions

Multi-Point Options

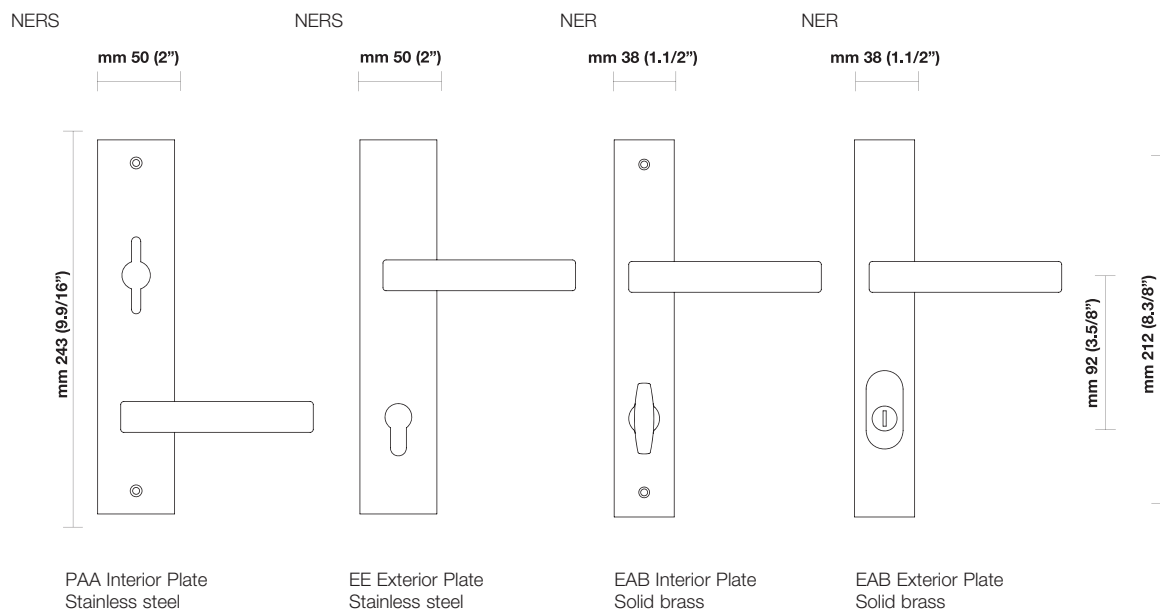
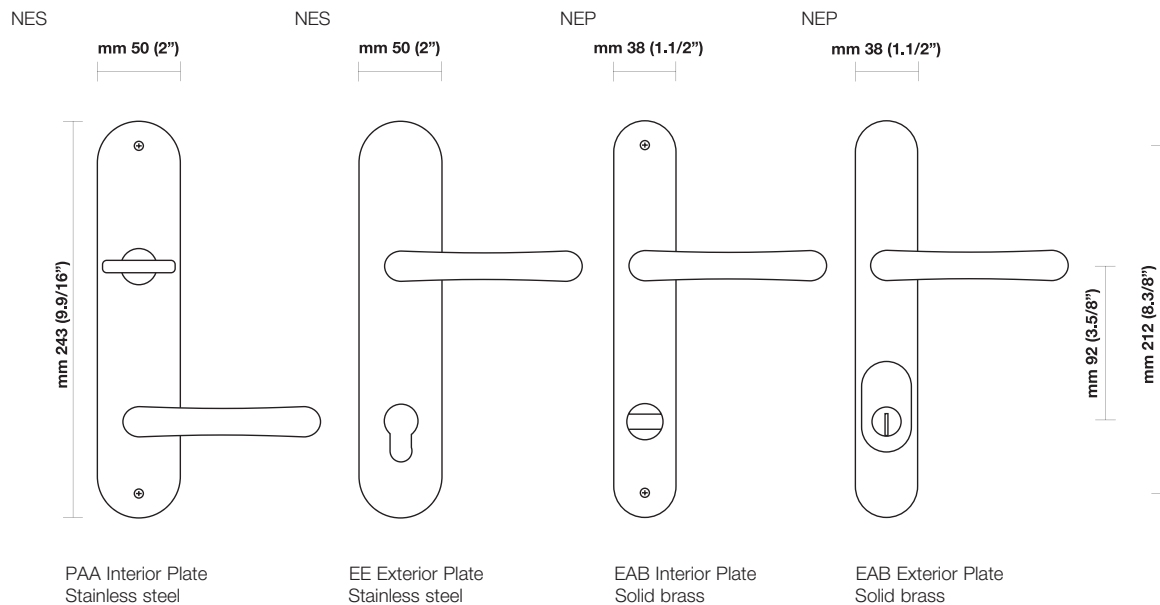

# How to order

## Multi-Point and Narrow Long Escutcheon plates

### MULTI-POINT & NARROW LONG ESCUTCHEON PLATES

To order these products, informations should be specified in the same sequence as the example given:

<b>1.Lever/Knob</b>	<b>2.Trim options</b>	<b>3.Function</b>	<b>4.Finish</b>	<b>5.Handing</b>	<b>6.Miscellaneous</b>
HXXX	NEP (Brass) NES (Inox)	EE	15	RH	KA4

**1. Lever** - choose from Valli&Valli product lines.

**2. Trim Options** - narrow long escutcheon plates or round rosettes - choose from the following:

- NEP plain style, narrow long escutcheon plate in solid brass.
- NES plain style, narrow long escutcheon plate in stainless steel.
- RSM plain style, small 1.3/4" (45mm) rosette in solid brass. Includes profile cylinder with matching rosettes.
- RSSM plain style, small 2" (50mm) rosette in stainless steel. Includes profile cylinder with matching rosettes.
- NER narrow long rectangular escutcheon plate in solid brass
- NERS narrow long rectangular escutcheon plate in stainless steel

**3. Function** - choose from the following:

- EAB entry function with American cylinder below the lever or knob (92mm center to center).
- EAA entry function with American cylinder above the lever or knob (92mm center to center).
- PAB patio function with thumbturn only, below the lever or knob.
- PAA patio function with thumbturn only, above the lever or knob.
- EE entry function with European profile cylinder (92mm center to center).
- PE patio function with European 1/2 profile cylinder (thumbturn).
- CE entry or patio function with custom center to center sizes. Supplied with profile cylinder.
- PGE passage function with tubular latch. For interior doors.
- PCY privacy function with tubular latch and privacy bolt. For interior doors.
- DA pair dummy, active with through spindle.
- DS single dummy, surface mounted spindle.

**4. Finishes** - choose from stock or custom ordered finishes. See price list for options.

- Special finishes available. Add \$ 100.00 NET cost to the polished brass price.
- Valli&Valli Inox is only available in 32D satin stainless steel. No plating of stainless steel hardware.

**5. Handing**

- All sets require handing. See handing diagram on page 172.

**6. Miscellaneous**

- Special door thickness, keying info., split finishes.
- Maximum 2.1/4" thick door.
- Additional charges apply to these special details. Call factory for pricing.

**7. Generic Codes**

- K 1789 NEP solid brass
- K 1805 NER solid brass
- K 5701 NES stainless steel
- K 5713 NERS stainless steel

# V&V Multi-Point

Material: Solid brass

**GROUP I**

H 163, H 192, H 195, H 198, H 1003, H 1004, H 1012, H 1017, H 1022, H 1024, H 1037, H 1038, H 1050, K 1168

		Retail Price		
		NEP 03 - 15	NER 26 - 26D	RSM 03 - 15
<b>EAB</b>	<b>Entry Set - key below</b>	\$ 440.00	\$ 546.00	-
<b>PAB</b>	<b>Patio Set - no keyway</b>	\$ 370.00	\$ 470.00	-
<b>EAA</b>	<b>Entry Set - key above</b>	\$ 440.00	\$ 546.00	-
<b>PAA</b>	<b>Patio Set - no keyway</b>	\$ 370.00	\$ 470.00	-
<b>EE</b>	<b>Entry Set - with profile cyl.</b>	\$ 690.00	\$ 770.00	\$ 665.00
<b>PE</b>	<b>Patio Set - profile cyl. no key</b>	\$ 430.00	\$ 520.00	\$ 356.00
<b>CE</b>	<b>Entry Set - custom</b>	Call factory		
<b>DA</b>	<b>Active Dummy</b>	\$ 335.00	\$ 430.00	\$ 225.00

**GROUP II**

H 165, H 174, H 176, H 179, H 1015, H 1016, H 1018, H 1026, H 1027, H 1045, H 1046, H 1049, H 1051

		Retail Price		
		NEP 03 - 15	NER 26 - 26D	RSM 03 - 15
<b>EAB</b>	<b>Entry Set - key below</b>	\$ 500.00	\$ 606.00	-
<b>PAB</b>	<b>Patio Set - no keyway</b>	\$ 430.00	\$ 525.00	-
<b>EAA</b>	<b>Entry Set - key above</b>	\$ 500.00	\$ 606.00	-
<b>PAA</b>	<b>Patio Set - no keyway</b>	\$ 430.00	\$ 525.00	-
<b>EE</b>	<b>Entry Set - with profile cyl.</b>	\$ 750.00	\$ 825.00	\$ 725.00
<b>PE</b>	<b>Patio Set - profile cyl. no key</b>	\$ 490.00	\$ 575.00	\$ 422.00
<b>CE</b>	<b>Entry Set - custom</b>	Call factory		
<b>DA</b>	<b>Active Dummy</b>	\$ 395.00	\$ 486.00	\$ 286.00

**NOTE**

NEP: 03-15 Standard finish. Add \$ 100.00 net for non standard finish.

NER: 26-26D Standard finish. Add \$ 100.00 net for non standard finish.

NEP: Narrow long escutcheon plate (solid brass).

NER: Narrow long escutcheon rectangular plate (solid brass).

RSM: Small 1.3/4" round rosette (brass). RSM include profile cylinder with matching rosettes.

# V&V Multi-Point

Material: Solid brass

## GROUP III

H 1039, H 1042

		Retail Price		
		NEP 03 - 15	NER 26 - 26D	RSM 03 - 15
<b>EAB</b>	<b>Entry Set - key below</b>	\$ 639.00	\$ 747.00	-
<b>PAB</b>	<b>Patio Set - no keyway</b>	\$ 568.00	\$ 664.00	-
<b>EAA</b>	<b>Entry Set - key above</b>	\$ 639.00	\$ 747.00	-
<b>PAA</b>	<b>Patio Set - no keyway</b>	\$ 568.00	\$ 664.00	-
<b>EE</b>	<b>Entry Set - with profile cyl.</b>	\$ 890.00	\$ 970.00	\$ 860.00
<b>PE</b>	<b>Patio Set - profile cyl. no key</b>	\$ 628.00	\$ 710.00	\$ 573.00
<b>CE</b>	<b>Entry Set - custom</b>	Call factory		
<b>DA</b>	<b>Active Dummy</b>	\$ 530.00	\$ 628.00	\$ 437.00

### NOTE

NEP: 03-15 Standard finish. Add \$ 100.00 net for non standard finish.

NER: 26-26D Standard finish. Add \$ 100.00 net for non standard finish.

NEP: Narrow long escutcheon plate (solid brass).

NER: Narrow long escutcheon rectangular plate (solid brass).

RSM: Small 1.3/4" round rosette (brass). RSM include profile cylinder with matching rosettes.

# V&V Multi-Point

Material: Zamak alloy UNI 3717

**GROUP IV**

H 412, H 417, H 421, H 1043, H 1044, H 4705, H 4707, H4730, H 4734, H 4742, H 4744

		Retail Price		
		NEP 03 - 15	NER 26 - 26D	RSM 03 - 15
<b>EAB</b>	<b>Entry Set - key below</b>	\$ 415.00	\$ 515.00	-
<b>PAB</b>	<b>Patio Set - no keyway</b>	\$ 345.00	\$ 440.00	-
<b>EAA</b>	<b>Entry Set - key above</b>	\$ 415.00	\$ 515.00	-
<b>PAA</b>	<b>Patio Set - no keyway</b>	\$ 345.00	\$ 440.00	-
<b>EE</b>	<b>Entry Set - with profile cyl.</b>	\$ 665.00	\$ 750.00	\$ 640.00
<b>PE</b>	<b>Patio Set - profile cyl. no key</b>	\$ 402.00	\$ 490.00	\$ 342.00
<b>CE</b>	<b>Entry Set - custom</b>	Call factory		
<b>DA</b>	<b>Active Dummy</b>	\$ 310.00	\$ 405.00	\$ 206.00

Material: Stainless steel AISI 304

**V&V INOX**

H 414, H 415, H 416, H 419

		Retail Price		
		NES - 32D	NERS - 32D	RSSM - 32D
<b>EAB</b>	<b>Entry Set - key below</b>	\$ 524.00	\$ 592.00	-
<b>PAB</b>	<b>Patio Set - no keyway</b>	\$ 433.00	\$ 482.00	-
<b>EAA</b>	<b>Entry Set - key above</b>	\$ 525.00	\$ 585.00	-
<b>PAA</b>	<b>Patio Set - no keyway</b>	\$ 435.00	\$ 482.00	-
<b>EE</b>	<b>Entry Set - with profile cyl.</b>	\$ 730.00	\$ 780.00	\$ 550.00
<b>PE</b>	<b>Patio Set - profile cyl. no key</b>	\$ 472.00	\$ 474.00	\$ 289.00
<b>CE</b>	<b>Entry Set - custom</b>	Call factory		
<b>DA</b>	<b>Active Dummy</b>	\$ 355.00	\$ 398.00	\$ 158.00

**NOTE**

NEP: 03-15 Standard finish. Add \$ 100.00 net for non standard finish.  
 NER: 26-26D Standard finish. Add \$ 100.00 net for non standard finish.  
 NEP: Narrow long escutcheon plate (solid brass).  
 NER: Narrow long escutcheon rectangular plate (solid brass).  
 RSM: Small 1.3/4" round rosette (brass). RSM include profile cylinder with matching rosettes.  
 NES/RSSM/NERS: Available only in 32D finish.  
 NERS/NES: Narrow long escutcheon plate (Stainless steel).  
 RSSM: Small 2" round rosette (Stainless steel). RSSM include profile cylinder with matching rosettes.





# Desipro Program



## Desipro Program

There are many kinds of motor handicaps and it is therefore correct to state that each disabled person should have access to his own objects, purposely designed for him, as his own personal aids or protheses. In reality, this statement, even if true, is a mere utopia that is not always attainable. Valli&Valli with their Desipro handles have got around this problem with the procedure "design in progress." The Desipro programme for disabled people is in fact a progressive transformation of just one handle.

When we planned the Desipro programme it was with the expectation that it would be completed by mid-eighties: the fiftieth anniversary of our company's establishment.

In our opinion, such an important occasion should have been celebrated by an initiative with a social dimension, not merely commercial.

Therefore, we thought of making a modest contribution in our specific field of handles, availing ourselves of our long experience in this area, by studying a programme aimed at overcoming the prehensile (grip) difficulties of handicapped, disabled and elderly people in their everyday life; in this connection we contacted Arch. Attilio Marcolli, who immediately greeted the concept with enthusiasm.

It was in this atmosphere that the Desipro programme was conceived.

However, the research, planning and setting up of the various models extended far beyond 1984, with far greater costs than envisaged and normally allocated in one of our more complex collections. Nevertheless, we continued with our intent, with the assistance of our co-operators who proceeded with the same amount of devotion to this purpose.

At that point the Desipro programme became a challenge to the productive capacities of our company, as well as a moral obligation to those involved in its realization.

Our initiative represents a victory for progress and a positive expression of quality in life.

Miscellaneous  
parts

# Miscellaneous replacement parts

## TUBULAR LATCH BOLTS 28 DEGREE

Part No.	Overall size latch	Retail Price			
		03	06	26	26D/15
01E 2.3/8" backset, passage	3.1/4"	\$ 40.00	\$ 40.00	\$ 40.00	\$ 40.00
02E 2.3/4" backset, passage	3.5/8"	\$ 40.00	\$ 40.00	\$ 40.00	\$ 40.00
03E 2.3/8" backset, privacy	3.1/4"	\$ 50.00	\$ 50.00	\$ 50.00	\$ 50.00
04E 2.3/4" backset, privacy	3.5/8"	\$ 50.00	\$ 50.00	\$ 50.00	\$ 50.00
01UL 2.3/8" backset, passage 	3.11/32"	\$ 300.00	-	-	-
02UL 2.3/4" backset, passage 	3.3/4"	\$ 300.00	-	-	-

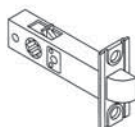

Includes: face plate, strike plate and screws. Retracts 28°.

## DEADBOLT LATCH & PRIVACY BOLTS

Part No.	Overall size latch	Retail Price				
		03	06	15	26	26D
09 2.3/8" backset	3.1/4"	\$ 70.00	\$ 70.00	\$ 70.00	\$ 70.00	\$ 70.00
10 2.3/4" backset	3.5/8"	\$ 70.00	\$ 70.00	\$ 70.00	\$ 70.00	\$ 70.00
Above Includes: deadbolt latch, mortise cylinder housing, strike plate for both metal and wood jambs, face plate and screws (no cylinder).						
X 30 2.3/8" privacy bolt	3.5/16"	\$ 42.00	\$ 42.00	\$ 42.00	\$ 42.00	\$ 42.00
X 31 2.3/4" privacy bolt	3.3/4"	\$ 42.00	\$ 42.00	\$ 42.00	\$ 42.00	\$ 42.00

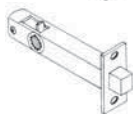

## HOUSINGS

		Retail Price
X 2122	Housing, no spring	\$ 23.00 each
X 2124M	Housing, spring loaded for long escutcheon plates	\$ 20.00 each
X 1115	Interior underosette to mount interior deadbolt trim	\$ 48.00 each
X 1116	Underosettes for mounting mortise lock round rosettes	\$ 137.00 pair
X 0550	Underosettes for mounting deadbolt square roses	\$ 15.00 pair
X 0547	Underosettes for mounting mortise lock square roses	\$ 38.00 pair

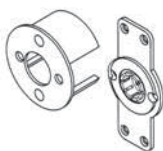

## STRIKE PLATES

Part No.		Retail Price				
		03	06	15	26	26D
TS 01	T-strikes (tubular latch)	\$ 8.00	-	\$ 8.00	\$ 8.00	\$ 8.00
ETS-115	extended for doors 2.1/4" thick	\$ 40.00	\$ 40.00	\$ 40.00	\$ 40.00	\$ 40.00
ETS-175	extended for doors 2.1/2" & up	\$ 40.00	\$ 40.00	\$ 40.00	\$ 40.00	\$ 40.00
FL 01	Full lip (tubular latch)	\$ 7.00	\$ 7.00	\$ 7.00	\$ 7.00	\$ 7.00
EL-115	extended for doors 2.1/4" thick	\$ 40.00	\$ 40.00	\$ 40.00	\$ 40.00	\$ 40.00
EL-175	extended for doors 2.1/2" & up	\$ 40.00	\$ 40.00	\$ 40.00	\$ 40.00	\$ 40.00
ML 01	Mortise lock strike (standard)	\$ 40.00	\$ 40.00	\$ 40.00	\$ 40.00	\$ 40.00
ML 02	extended for 2.1/4" doors	\$ 50.00	\$ 50.00	\$ 50.00	\$ 50.00	\$ 50.00
ML 03	extended for 2.3/8" & up	\$ 50.00	\$ 50.00	\$ 50.00	\$ 50.00	\$ 50.00

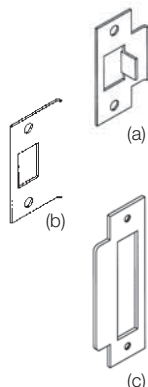



(a) T-strike (b) Full Lip (c) Mortise strike

# Miscellaneous replacement parts

## ROSETTES

Retail Price

RT Traditional 2.9/16" (65mm)	03/03D	06-06A	06B	14	15	26/26D	
	K 1749 RS (ML) threaded each	\$ 39.00	\$ 39.00	\$ 39.00	\$ 46.00	\$ 40.00	\$ 39.00
	K 1741 RRS PGE CP	\$ 33.00	\$ 48.00	\$ 52.00	\$ 52.00	\$ 42.00	\$ 33.00
	K 1741 RRS PCY CPK	\$ 47.00	\$ 54.00	\$ 57.00	\$ 70.00	\$ 55.00	\$ 47.00
	K 1741 RRS SF (DMY) each	\$ 18.00	\$ 24.00	\$ 26.00	\$ 26.00	\$ 21.00	\$ 18.00

RP Plain 2.9/16" (65mm)	03-03D	06A	06B	14	15	26	26D	
	K 1748 RS (ML) threaded each	\$ 37.00	\$ 39.00	\$ 43.00	\$ 47.00	\$ 43.00	\$ 37.00	\$ 43.00
	K 1742 RRS PGE CP	\$ 39.00	\$ 62.00	\$ 45.00	\$ 40.00	\$ 46.00	\$ 37.00	\$ 41.00
	K 1742 RRS PCY CPK	\$ 47.00	\$ 78.00	\$ 57.00	\$ 50.00	\$ 55.00	\$ 42.00	\$ 48.00
	K 1742 RRS SF (DMY) each	\$ 18.00	\$ 32.00	\$ 23.00	\$ 20.00	\$ 23.00	\$ 17.00	\$ 21.00

RS Plain 1.3/4" (45mm)	03-03D	06A	06B	15	26	26D	
	K 1112 RS	\$ 28.00	\$ 30.00	\$ 28.00	\$ 30.00	\$ 28.00	\$ 30.00

RSQ Plain 1.3/4" (45mm)	26	26D	
	K 386 RS	\$ 40.00	\$ 44.00

RPS Stainless steel 2.9/16" (65mm)	32	32D	
	R 5701 (ML) threaded each	\$ 128.00	\$ 98.00
	R 5703 RRS PGE	\$ 102.00	\$ 70.00
	R 5703 RRS PCY CPK	\$ 119.00	\$ 70.00
	R 5703 RRS SF (DMY) each	\$ 52.00	\$ 36.00

RSS Stainless steel 2" (50mm)	32	32D	
	R 5704 RRS PGE	\$ 72.00	\$ 51.00
	R 5702 RS (DMY) each	\$ 23.00	\$ 19.00

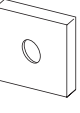
RQ Square 2.9/16" (65mm)	14	15	26	26D	
	K 1780 RS I (inside) ML each	\$ 89.00	\$ 88.00	\$ 75.00	\$ 88.00
	K 1780 RS E (outside) ML each	\$ 89.00	\$ 88.00	\$ 75.00	\$ 88.00
	K 1798 RRS PGE	\$ 166.00	\$ 153.00	\$ 140.00	\$ 153.00
	K 1798 RRS PCY	\$ 178.00	\$ 162.00	\$ 148.00	\$ 162.00
	K 1798 RRS (DMY) each	\$ 89.00	\$ 88.00	\$ 75.00	\$ 88.00

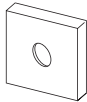
**ROSETTES**
**Retail Price**
**RQS Stainless steel Square 2.9/16" (65mm)**
**32 32D**

R 5709 RS I (inside) ML each	\$ 150.00	\$ 115.00
R 5709 RS E (outside) ML each	\$ 150.00	\$ 115.00
R 5707 RRS PGE	\$ 284.00	\$ 220.00
R 5707 RRS PCY	\$ 309.00	\$ 237.00
R 5707 RRS DMY each	\$ 150.00	\$ 115.00

**MORTISE CYLINDERS - C Keyway**
**Retail Price**
**Part No. Door Thickness 03 06A-06B 15 26 26D**

**(D)**

**(M)**

C 01 15/16 cyl. 1.3/8" D	\$ 40.00	\$ 40.00	\$ 40.00	\$ 40.00	\$ 40.00
C 02 1-1/8 cyl. 1.3/4" D	\$ 40.00	\$ 40.00	\$ 40.00	\$ 40.00	\$ 40.00
C 03 1-1/4 cyl. 2" D - 1.3/4" M	\$ 40.00	\$ 40.00	\$ 40.00	\$ 40.00	\$ 40.00
C 04 1-3/8 cyl. 2.1/4" D - 2" M	\$ 40.00	\$ 40.00	\$ 40.00	\$ 40.00	\$ 40.00
C 05 1-1/2 cyl. 2.1/2" D - 2.1/4" M	\$ 40.00	\$ 40.00	\$ 40.00	\$ 40.00	\$ 40.00
C 06 cust. length 3" D - 2.1/2" - 3" M	Call Factory				

Must specify Deadbolt (D) or Mortise Lock (M). Straight cam is used for mortise locks without thumbturns.

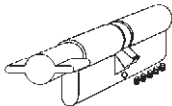
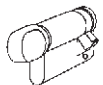
**PROFILE CYLINDERS - C Keyway**
**Retail Price**
**Part No. Description Door Thickness 03 26 15-26D 32D**

C 07 35 mm	Key by thumbturn		\$ 40.00	\$ 40.00	\$ 40.00	-
C 08 72 mm	Key by thumbturn profile cylinder	1.3/4"	\$ 300.00	\$ 300.00	\$ 300.00	-
C 09 81 mm	Key by thumbturn profile cylinder	2.1/4"	\$ 300.00	-	\$ 300.00	-
C 12 45 mm	Half profile cylinder with thumbturn		\$ 300.00	\$ 300.00	\$ 300.00	-
C 13 50 mm	Half profile cylinder with thumbturn		\$ 300.00	-	\$ 300.00	-
C 14 45 mm	Half profile cylinder with keyway		\$ 300.00	-	\$ 300.00	-
C 15 50 mm	Half profile cylinder with thumbturn		\$ 300.00	-	\$ 300.00	-
K 1799/6	Thumbturn for profile cylinder (brass)		\$ 39.00	\$ 39.00	\$ 43.00	-
S 5702 BZG MP	Thumbturn for profile cylinder (stainless steel)		-	-	-	\$ 75.00

Must add price of thumbturn to profile cylinder.

**ALLEN WRENCHES & SET SCREW (metric)**
**Retail Price**

X 0285 set screws with allen wrench for brass levers and knobs	\$ 5.00
X 0286 stainless steel set screws with allen wrench	\$ 12.00
W 04 for deadbolt cylinder locking screw	\$ 2.00

 Set screws with allen wrenches for brass levers and knobs  
 Set screws size ø=mm 6 wide x 9 long

**DUST BOX**
**Retail Price**
**Part No. Description 03D 06B 32D Black**

DB-01	Dust Box T Strike		-	-	\$ 4.00
DB-03	Dust Box Full Lip Strike		-	-	\$ 4.00
DB-02	Dust Box Mortise Lock	\$ 4.00	\$ 4.00	\$ 9.00	-



# Miscellaneous replacement parts

## MORTISE LOCKS

Must specify 2.1/2" or 2.3/4" backset. Must specify for levers or knobs. Includes: mortise lock body, face plate, strike plate, screws and dust box (no cylinder). Custom mortise locks and other backsets available upon special request. See page 166.



UL listed 3 hours fire rating.

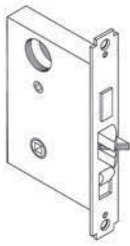

Part No.	Description	Retail price	
		2.1/2" - 2.3/4"	
ML F	Entrance (Lever Sets)	\$	400.00
ML FD	Entrance	\$	400.00
ML FW	Entrance	\$	300.00
ML J	Classroom	\$	400.00
ML AC	Entrance	\$	300.00
ML N	Passage	\$	300.00
ML B	Entrance	\$	300.00
ML NC	Communicating	\$	200.00
ML E	Office	\$	400.00
ML LF	Privacy	\$	300.00
ML ELEC	Electrified	\$	2,000.00
ML EW	Storeroom	\$	300.00
ML H	Hotel	\$	300.00

See page 184 for lock function details.

## SPINDLES

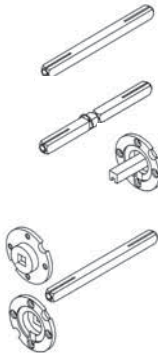





Part No.	Description	Overall length	Retail price	
X 016	8mm, solid spindle for doors 1.3/8" to 2.1/4"	4.1/2"	\$	10.00
X 0102	8mm, solid spindle for doors 2.3/8" to 3"	5.5/8"	\$	19.00
X 0163/X 1119-114	8mm, two piece spindle for doors 1.3/8" to 2.1/4"	4.1/2"	\$	11.00
X 0163/X 1119-145	8mm, two piece spindle for doors 2.3/8" to 3"	5.3/4"	\$	13.00
X 0571	8mm, surface mounted dummy		\$	23.00
X 0571 OT SQ	8mm, surface mounted dummy (NEP only)		\$	26.00
X 0572	8mm, opposing mounted dummy plates		\$	25.00
X 1118	5mm/tailpiece, for deadbolts with doors 1.3/8" to 1.3/4"		\$	4.00
X 117/5-60	5mm x 60mm, for mortise lock functions with doors 1.3/4"		\$	3.00
X 117/5-85	5mm x 85mm, for 105 privacy bolts with doors up to 1.3/4"		\$	3.00
		<b>32</b>		<b>32D</b>
X 0147	8mm, two piece spindle for H 5019		\$ 126.00	\$ 103.00
X 0148	8mm, surface mounted dummy for H 5019		\$ 72.00	\$ 60.00

## DEADBOLT, PRIVACY BOLT, MORTISE TRIM ONLY

Part No.	Retail Price									
	03/03D	06A	06B	14	15	26	26D	32	32D	26/26D
K 1724 RS BZG Interior trim for 105 RST (traditional)	\$ 78.00	\$ 106.00	\$ 78.00	\$ 94.00	\$ 85.00	-	-	-	-	\$102.00
K 1724 RS V BZG Exterior trim for 105 RST (traditional)	\$ 78.00	\$ 106.00	\$ 78.00	\$ 94.00	\$ 85.00	-	-	-	-	\$102.00
K 1725 RS BZG Interior trim for 105 RSP (plain)	\$ 70.00	\$ 94.00	\$ 70.00	\$ 89.00	\$ 83.00	\$ 68.00	\$ 83.00	-	-	-
K 1725 RS V BZG Exterior trim for 105 RSP (plain)	\$ 70.00	\$ 70.00	\$ 70.00	\$ 89.00	\$ 83.00	\$ 68.00	\$ 83.00	-	-	-
S 5700 RS BZG Interior trim for 105 RSS (stainless steel)	-	-	-	-	-	-	-	\$181.00	\$ 156.00	-
S 5700 RS V BZG Exterior trim for 105 RSS (stainless steel)	-	-	-	-	-	-	-	\$141.00	\$ 108.00	-

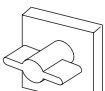
**DEADBOLT & PRIVACY BOLT, MORTISE TRIM ONLY**

Part No.	Retail Price									
	03/03D	06A	06B	14	15	26	26D	32	32D	26/26D
K 1781 RS BZG Interior trim for 105 RSQ (square)	-	-	-	\$ 164.00	\$ 150.00	\$ 136.00	\$ 150.00	-	-	-
K 1781 RS VBZG Exterior trim for 105 RSQ (square)	-	-	-	\$ 170.00	\$ 150.00	\$ 136.00	\$ 150.00	-	-	-
S 5703 RS BZG Interior trim for 105 RSQS (square) stainless steel	-	-	-	-	-	-	-	\$ 245.00	\$ 188.00	-
S 5703 RS VBZG Exterior trim for 105 RSQS (square) stainless steel	-	-	-	-	-	-	-	\$ 175.00	\$ 134.00	-
 K 1728 RS BZG Interior trim for traditional deadbolt (101 RT)	\$ 67.00	\$ 87.00	\$ 67.00	\$ 78.00	\$ 75.00	-	\$ 67.00	-	-	-
K 1749 RSC Exterior trim for traditional deadbolt (101 RT)	\$ 38.00	\$ 36.00	\$ 38.00	\$ 41.00	\$ 40.00	-	-	-	-	\$ 38.00
 K 1729 RS BZG Interior trim for plain deadbolt (101 RP)	\$ 91.00	\$ 91.00	\$ 67.00	\$ 75.00	\$ 74.00	\$ 67.00	\$ 75.00	-	-	-
K 1748 RSC Exterior rosette for plain deadbolt (101 RP)	\$ 41.00	\$ 44.00	\$ 45.00	\$ 45.00	\$ 45.00	\$ 41.00	\$ 45.00	-	-	-
R 5701 RS BZG Interior trim for stainless steel deadbolt (101 RPS)	-	-	-	-	-	-	-	\$ 221.00	\$ 168.00	-
 R 5705 RS Exterior trim for stainless steel deadbolt (101 RPS)	-	-	-	-	-	-	-	\$ 126.00	\$ 97.00	-
R 5708 RS BZG Interior trim for stainless steel deadbolt (101 RQS)	-	-	-	-	-	-	-	\$ 247.00	\$ 191.00	-
 R 5709 RS Exterior trim for stainless steel deadbolt (101 RQS)	-	-	-	-	-	-	-	\$ 156.00	\$ 119.00	-
K 1778 RS BZG Interior trim for brass deadbolt (101 RQ)	-	-	-	\$ 150.00	\$ 150.00	\$ 136.00	\$ 150.00	-	-	-
 K 1780 RSC Exterior trim for brass deadbolt (101 RQ)	-	-	-	\$ 86.00	\$ 93.00	\$ 79.00	\$ 93.00	-	-	-
K 1726 Mortise lock cylinder collar (traditional)	\$ 43.00	\$ 48.00	\$ 44.00	\$ 43.00	\$ 43.00	\$ 36.00	\$ 40.00	-	-	-
K 1727 Mortise lock cylinder collar (plain)	\$ 51.00	\$ 51.00	\$ 44.00	\$ 46.00	\$ 46.00	\$ 41.00	\$ 43.00	-	-	-
R 5700 Mortise lock cylinder collar (stainless steel)	-	-	-	-	-	-	-	\$ 93.00	\$ 77.00	-
K 1767 Mortise lock cylinder collar (square)	-	-	-	\$ 103.00	\$ 94.00	\$ 86.00	\$ 94.00	-	-	-
R 5710 Mortise lock cylinder collar (square) stainless steel	-	-	-	-	-	-	-	\$ 129.00	\$ 99.00	-
X 1121 K Cylinder collar for exterior rosette for deadbolt (brass)	\$ 16.00	\$ 16.00	\$ 23.00	\$ 18.00	\$ 16.00	\$ 16.00	\$ 16.00	-	-	-
X 1121K/X 0237 Cylinder collar for exterior rosette for deadbolt (stainless steel)	-	-	-	-	-	-	-	\$ 40.00	\$ 32.00	-
K 1806/1225 RS BZG Interior trim for K 1225 RSQ (square)	-	-	-	\$ 165.00	\$ 150.00	\$ 140.00	\$ 150.00	-	-	-
K 1806/1225 RS VBZG Exterior trim for K 1225 RSQ (square)	-	-	-	\$ 170.00	\$ 150.00	\$ 140.00	\$ 150.00	-	-	-

# Miscellaneous replacement parts

## PRIVACY PINS

Part No.	Description	Finish options	Retail Price
X 0227	for tubular latch (m3 thread)	03, 06A, 26, 26D	\$ 12.00
X 0248	for tubular latch stainless steel (m3 thread)	32	\$ 13.00
X 0248	for tubular latch stainless steel (m3 thread)	32D	\$ 11.00

## FASTENERS

Part No.	Description	Retail Price
X 176	Retaining ring to attach levers to rosettes and long escutcheons. Specify RH - LH	\$ 4.00
X 187	Metal washer	\$ 2.00
X 184	Retaining clip to attach thumbturns to rosettes and long escutcheons	\$ 2.00
X 1161	Locking o-ring to attach levers to rosettes and long escutcheon plates	\$ 2.00
X 1162	Stainless steel washer	\$ 2.00
X 1167	Stainless steel washer	\$ 2.00
X 0326	Nylon bushing to convert 8mm to 5mm	\$ 2.00
X 0339	Nylon bushing to convert 8mm to a flat tailpiece	\$ 2.00
X 1100	Spring for lever and rosette assembly	\$ 1.00
X 1107	Small nylon washer	\$ 1.00
X 1105	Medium nylon washer	\$ 1.00
X 1106	Large nylon washer	\$ 1.00

## SCREWS (Metric) Through screws for door sets.

Part No.	Description	Retail Price
X 15	standard pack for 1.3/8" or 1.3/4" doors (round rosettes)	\$ 1.00
X 17	standard pack for 1.3/8" or 1.3/4" doors (long escutcheons)	\$ 5.00
M4 x 30mm (1.1/4")		\$ 1.00
M4 x 40mm (1.1/2")		\$ 1.00
M4 x 50mm (2")		\$ 1.00
M4 x 70mm X0230 (2.3/4")		\$ 8.00
M4 x 90mm (3.1/2") non-cut & unfinished		\$ 1.00

**CABINET HARDWARE METRIC SCREWS**

Part No.		Retail Price
M4 x 6mm (1/4")		\$ 1.00
M4 x 8mm (5/16")		\$ 1.00
M4 x 10mm (3/8")		\$ 1.00
M4 x 12mm (1/2")		\$ 1.00
M4 x 20mm (3/4")		\$ 1.00
M4 x 25mm (1")	Standard size shipped unless otherwise specified	\$ 1.00
M4 x 30mm (1.1/4")		\$ 1.00
M4 x 40mm (1.1/2")		\$ 1.00
M4 x 45mm (1.3/4")		\$ 1.00
M4 x 50mm (2")		\$ 1.00
M6 x 20mm (3/4")		\$ 1.00
M6 x 25mm (1")		\$ 1.00
M6 x 30mm (1.1/4")		\$ 1.00
M6 x 90mm (3.1/2") Threaded rod		\$ 4.00
X 0216 Breadboard screw	Cabinet knob only	\$ 2.00

**DOOR HANDING**

The hand of a door is always determined from the outside.  
Always be sure to specify door handing for locking functions and dummy trim.

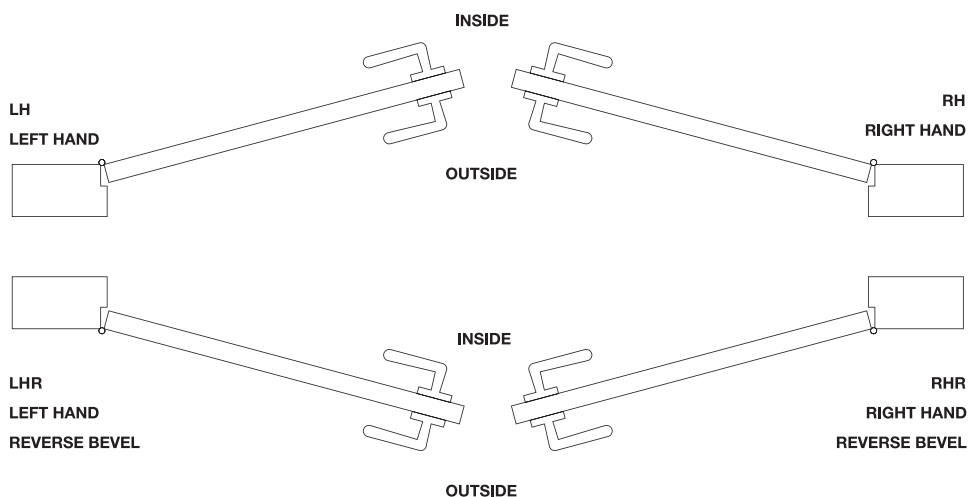

Technical  
information

# Door pulls application

X 0522

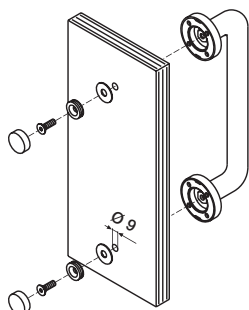

For installing a single pull handle with screw covering rosettes on a glass door, thickness 8 -12 mm, for items.  
**K 1210 - K 1188**

X 0523

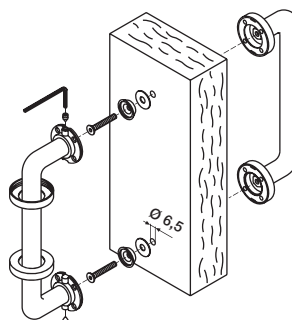

For installing a pair of pull handles with screw covering rosettes on a wooden door, thickness 45 - 55 mm 55-65 mm, for items.  
**K 1210 - K 1188**

X 0524

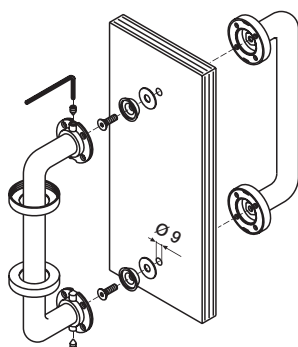

For installing a pair of pull handles with screw covering rosettes on a glass door, thickness 8 -12 mm, for items.  
**K 1210 - K 1188**

X 0525

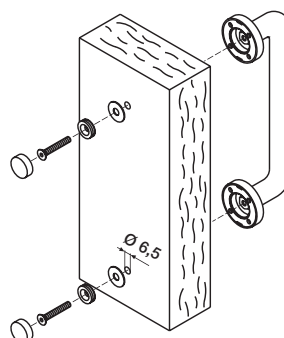

For installing a single pull handle with screw covering rosettes on a wooden door, thickness 45 - 55 mm 55-65 mm, for items.  
**K 1210 - K 1188**

X 0526

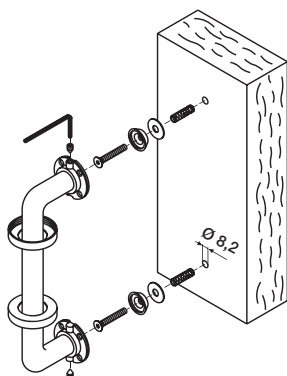

For installing a single pull handle with screw covering rosettes on a wooden door, or on a masonry wall using a brass anchor screw, for items.  
**K 1210 - K 1188**

X 0527

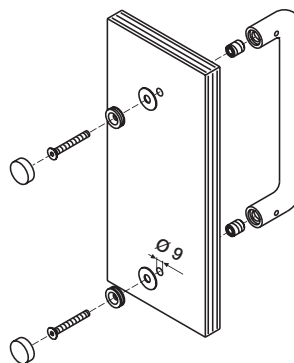

For installing a single pull handle without screw covering rosettes on a glass door, thickness 8 -12 mm, for items.  
**K 1219 - K 1224 - K 1226 - K 1228<sup>1</sup>**

# Door pulls application

X 0528

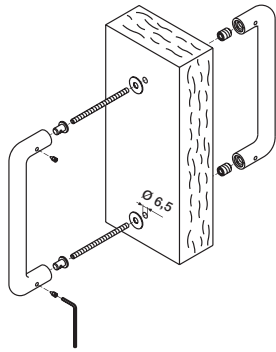

For installing a pair of pull handles without screw covering rosettes on a wooden door, thickness 45-55 mm 55-65 mm, for items.

**K 1219 - K 1224 - K 1226 - K 1228<sup>1</sup>**

X 0529

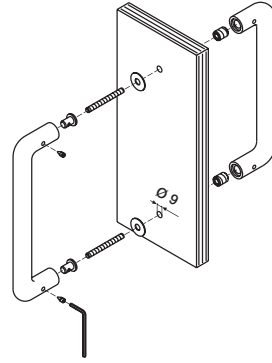

For installing a pair of pull handles without screw covering rosettes on a glass door, thickness 8-12 mm, for items.

**K 1219 - K 1224 - K 1226 - K 1228<sup>1</sup>**

X 0530

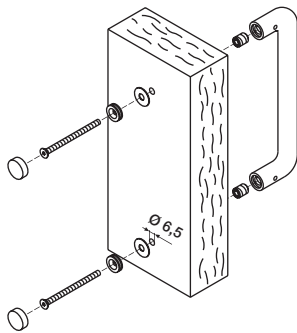

For installing a single pull handle without screw covering rosettes on a wooden door, thickness 45-55 mm 55-65 mm, for items.

**K 1219 - K 1224 - K 1226 - K 1228<sup>1</sup>**

X 0531

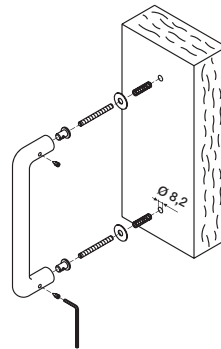

For installing a single pull handle without screw covering rosettes on a wooden door, or on a masonry wall using a brass anchor screw, for items.

**K 1219 - K 1224 - K 1226 - K 1228<sup>1</sup>**

X 0544

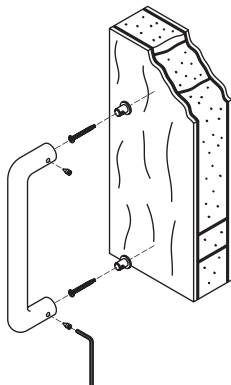

For installing a single pull handle without screw covering rosettes on a burglary-proof steel-clad door, for items.

**K 1219 - K 1224 - K 1226 - K 1228<sup>1</sup>**

X 0551

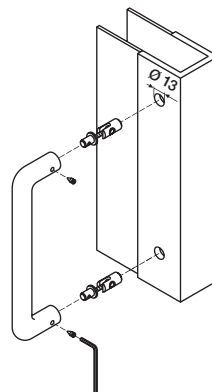

For installing a single pull handle without screw covering rosettes on an aluminum door, for items.

**K 1219 - K 1224 - K 1226 - K 1228<sup>1</sup>**

# Window lever application

**X 0601**  
Movement 4 click  
positions

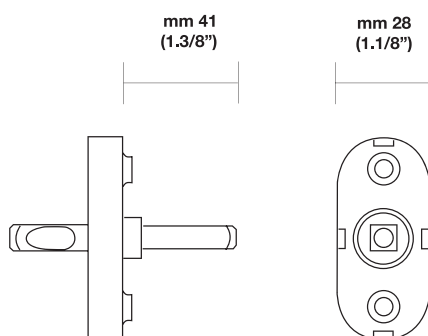

# Dummy set adaptor

Round Rose – Solid Brass

**X003/1 Double RP**

Set includes: 2 underosettes, 1 latch bolt blank  
BACKSET 2.3/4" and 2.3/8"  
Retail price \$ 75.00

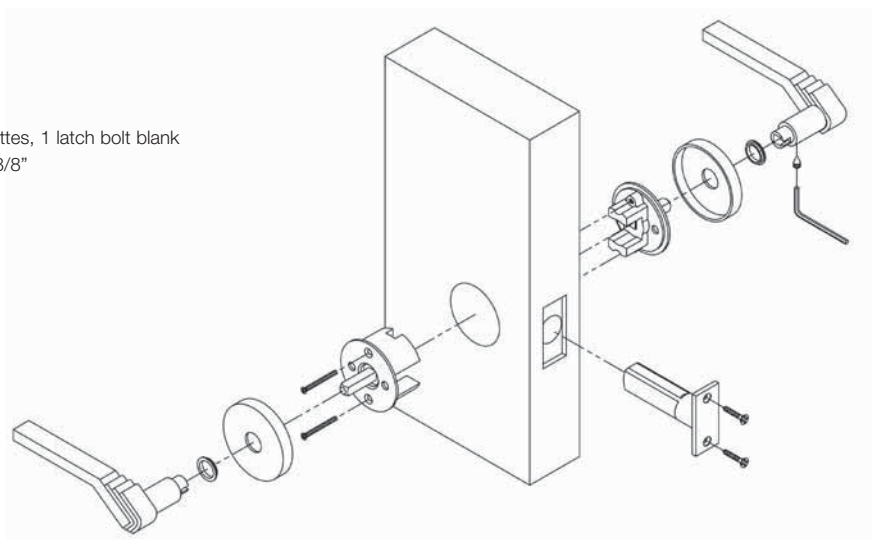

**X003/2 Single RP**

Set includes: 1 underosette, 1 latch bolt blank  
finished solid brass rosette for opposite side available  
in 26/chrome finish  
BACKSET 2.3/4" and 2.3/8"  
Retail price \$ 90.00

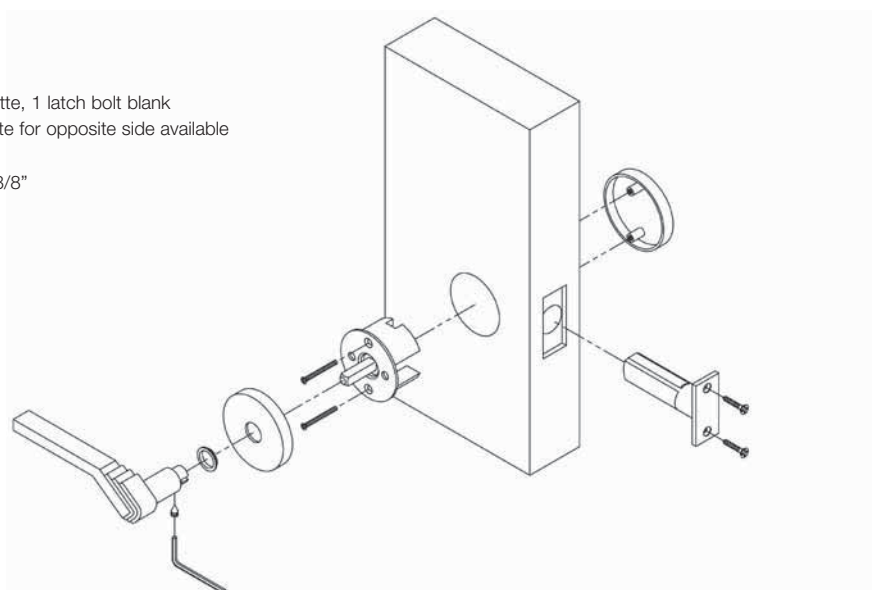



# Dummy set adaptor

Square Rose – Solid Brass

## X003/1 Double RQ

Set includes: 2 underosettes, 1 latch bolt blank  
BACKSET 2.3/4" and 2.3/8"  
Retail price \$ 75.00

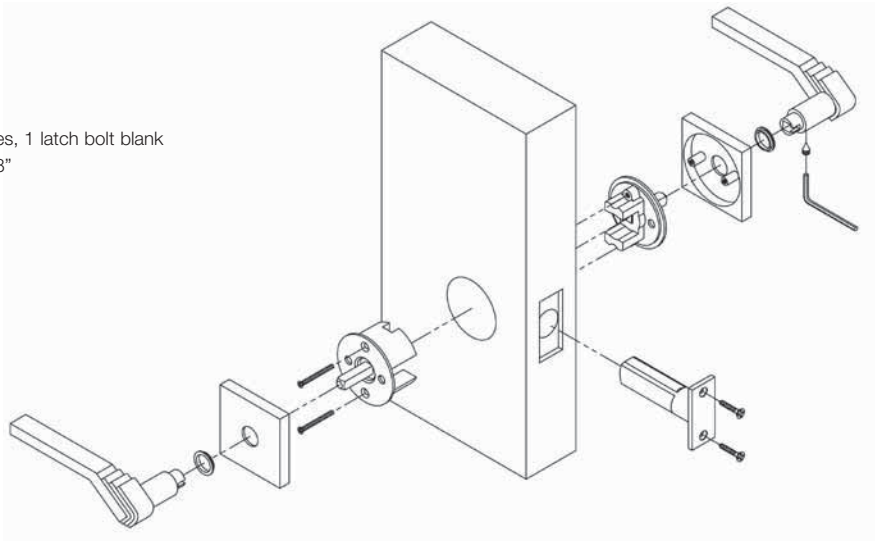

## X003/2 Single RQ

Set includes: 1 underosette, 1 latch bolt blank  
finished solid brass rosette for opposite side available  
in 26/chrome finish  
BACKSET 2.3/4" and 2.3/8"  
Retail price \$ 90.00

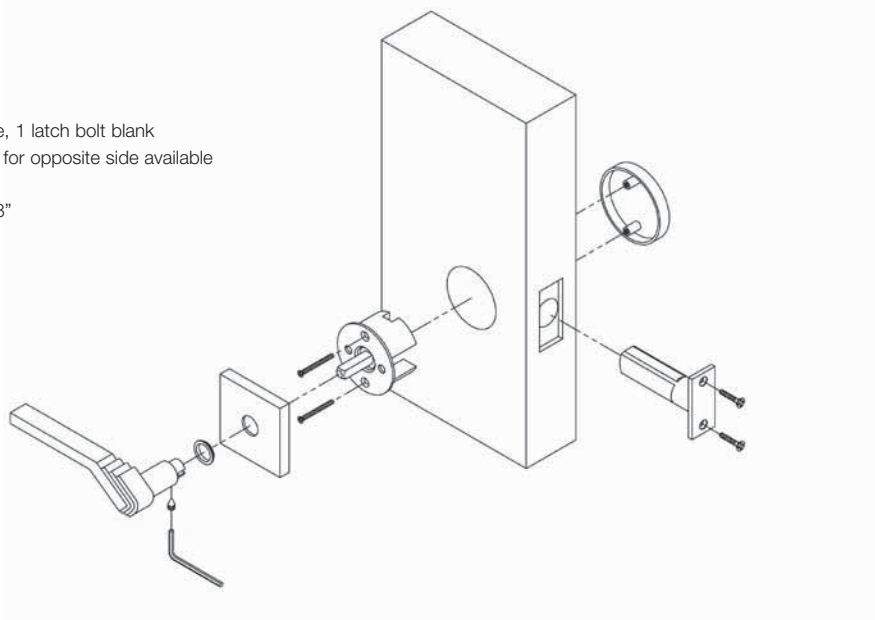

# Dummy set adaptor

Round Rose – Stainless Steel

## X003/1 Double RPS

Set includes: 2 underosettes, 1 latch bolt blank  
BACKSET 2.3/4" and 2.3/8"  
Retail price \$ 75.00

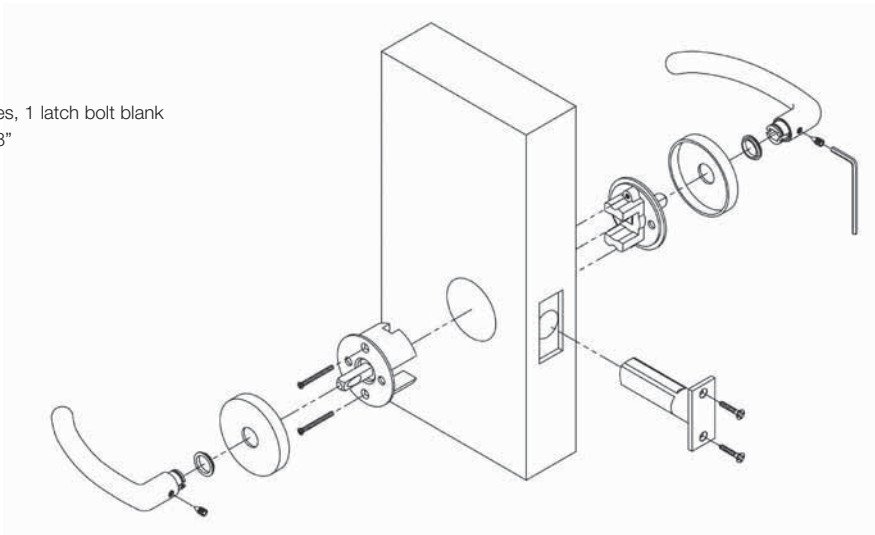

# Dummy set adaptor

Round Rose – Stainless Steel

## X003/2 Single RPS

Set includes: 2 underosettes, 1 latch bolt blank  
finished solid brass rosette for opposite side  
available in 26/chrome finish  
BACKSET 2.3/4" and 2.3/8"  
Retail price \$ 90.00

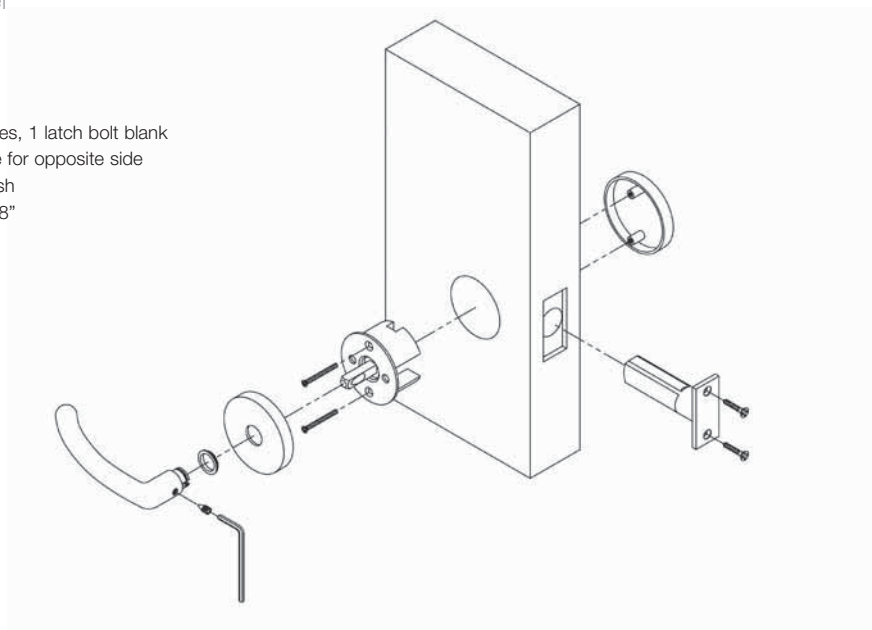

# Dummy set adaptor

Square Rose – Stainless Steel

## X003/1 Double RQS

Set includes: 2 underosettes, 1 latch bolt blank  
BACKSET 2.3/4" and 2.3/8"  
Retail price \$ 75.00

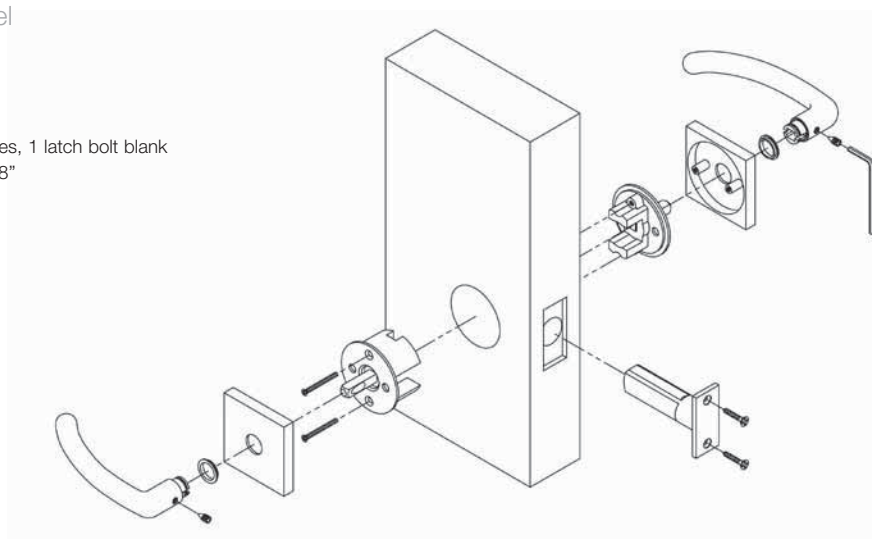

## X003/2 Single RQS

Set includes: 1 underosette, 1 latch bolt blank  
finished solid brass rosette for opposite side available  
in 26/chrome finish  
BACKSET 2.3/4" and 2.3/8"  
Retail price \$ 90.00

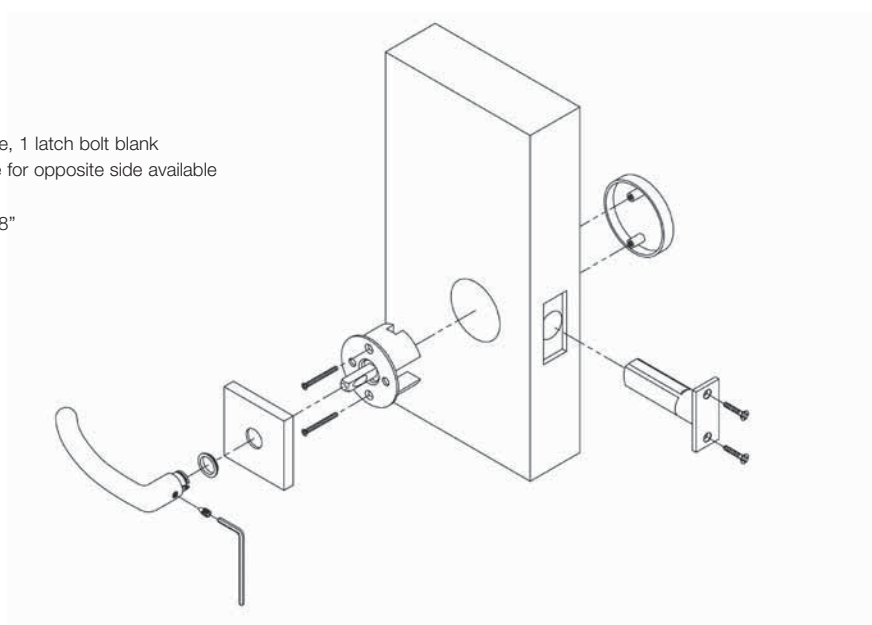

# Interior sets

## INTERIOR SETS WITH ROUND ROSETTES AND LONG ESCUTCHEON PLATES

**Passage** FIG. 1 (shown with RS small rosette trim)  
Reversible for right and left handed doors.

**Privacy** FIGS. 3, 4 and 5  
Rosette trim is reversible for right and left handed doors. Escutcheon plates require door handing to be specified. Integral push button privacy features inside panic release function and outside emergency release. NEP (narrow long escutcheon plates) use a privacy bolt. Privacy bolt also available as a function (see deadbolt specifications).

**Dummy** FIG. 2  
Must specify door handing for single dummy. Surface mounted spindle (X0571) or opposing spindle (X0572) available. Escutcheon plates with single dummy will have exposed mounting screws. Full dummy sets specified with R/L have exposed mounting screws on the interior only.

### Rosette Trim

RT Traditional style 2.9/16" (65mm) dia.  
RP Plain style 2.9/16" (65mm) dia.  
RQ Square style 2.9/16" (65mm) dia.  
RS Plain style 1.3/4" (45mm) dia.  
RSQ Square rosette (small) 1.3/4" (45mm).

Standard rosette (RT, RP, RQ) supplied is 2.9/16" (65mm).  
For 1.3/4" (45mm) small rosettes (RS, RSQ), please specify.

NOTE: The RS, RSQ rosettes can only be used for new doors which do not have a 2.1/8" cross bore hole. Privacy sets require a separate privacy bolt (105 RSP, 105 RSQ). No integral privacy sets are available with RS, RSQ rosettes. Heavy-duty springs attached to the rosette and lever provide added strength and durability (not supplied with knob sets). All rosette trims have concealed mounting screws.

### Escutcheon Plates

ET Traditional style  
EP Plain style  
ER Rectangular style  
NEP Narrow style

ET, EP, ER, escutcheon plate styles will cover a 2.1/8" cross bore hole.  
Heavy-duty, spring-loaded housings (X2124M) are included for added strength and durability.  
(Not supplied with knob sets.)  
NEP trim has springs attached to the escutcheon and lever.

### Door Thickness

Standard = 1.3/8" to 1.3/4".  
For any other size, please specify.

### Backset

Standard = 2.3/8". For 2.3/4" please specify.  
2" backset is also available for passage sets only. 03/brass finish only.

### Latch Bolt

1/2" throw with a 2.1/4" x 1" face plate.  
8 mm square hub size.  
28 degree latch reversible

### Strike Plate

Standard = T-strike 2.3/4" x 1.3/4" Lip size = 1.1/4"  
Full lip strikes are available upon special request.  
Square corner.

### Cross Bore

Fits in any standard 2.1/8" cross bore hole with a 1" edge bore.  
RS rosettes and NEP narrow long escutcheon plates require a 5/8" cross bore hole.

### Dust Box

Included.

**Figure 1**  
Passage Function  
RS trim

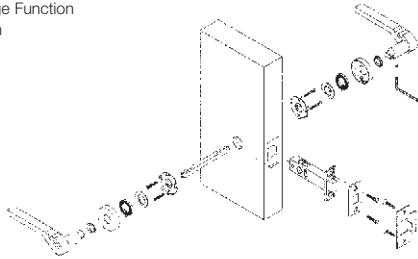

**Figure 2**  
Dummy Trim  
For rosette and escutcheons

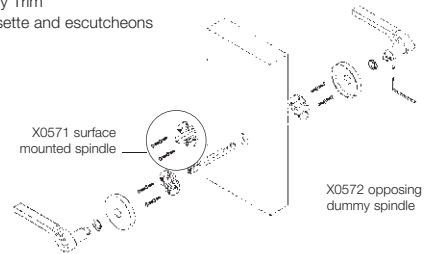

**Figure 3**  
Privacy Function  
For long escutcheon plates  
EP trim

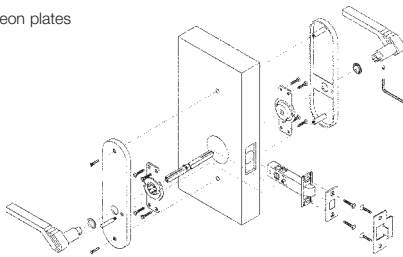

**Figure 4**  
Privacy Function  
NEP trim

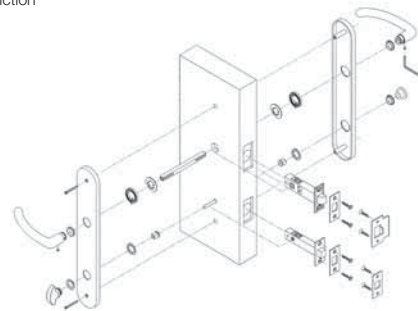

**Figure 5**  
Model Privacy RQ trim

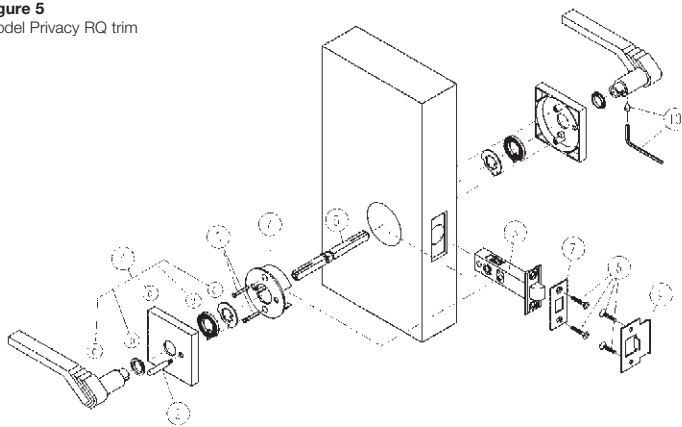

**Parts List**

1. Lever&Rosette Assemblies(2) includes:
  - a) lever
  - b) nylon washer
  - c) rosette
  - d) spring
  - e) retaining ring
2. Privacy pin (1)
3. Through screws (2)
4. Housing (1)
5. Two piece spindle (1)
6. Latch (1)
7. Face plate (1)
8. Wood screws (4)
9. Strike plate (1)
10. Allen wrench with 2 set screws (1)

# Deadbolts

## DEADBOLTS

### Functions

Single Cylinder (101) FIG. 10 and Double Cylinder (102) FIG. 6 available. Feature low profile trim (FIG. 9) designs which coordinate with all of our lever and knob styles. Include concealed mounting screws.

### Styles

RT Traditional  
RP Plain  
RQ Square

### Door Thickness

Standard = 1.3/4". For 1.3/8" doors or any other size, please specify.

### Backset

Standard = 2.3/8". For 2.3/4" please specify.

2" backset is also available upon special request. 03/brass finish only.

### Latch Bolt

1" throw with two hardened steel rods inside bolt for added security to resist sawing.

### Latch face

2" and 2.3/8" backset = 2.1/4" x 1"

2.3/4" backset = 2.1/4" x 1.1/8"

### Strike Plate

2.3/4" x 1.1/8" heavy duty for both wood and metal door jambs. Square corner.

### Cross Bore

Deadbolts fit into a standard 2.1/8" cross bore hole with a 1" edge bore.

### Cylinder

Solid brass, 5-pin, mortise cylinder with C-keyway.

## PRIVACY BOLTS

### Styles

105 RST=Traditional 105 RSP=Plain FIG. 7 105 RSQ=Square

Decorative thumbturn with emergency coin key release on exterior. Include concealed mounting screws.

Privacy bolts are also available with escutcheon plates (specify 106).

### Door Thickness

Standard=1.3/4". For 1.3/8" or any other size, please specify.

### Backset

Standard=2.3/8". For 2.3/4" please specify.

### Latch Bolt

1/2" throw with 2.1/4" x 1" face plate.

### Strike Plate

2.3/4" x 1.1/8". Square corner.

## ESCUTCHEONS WITH DEADBOLTS

### Functions

Passage with single cylinder (103) FIG. 8 or double cylinder (104) deadbolt.

Dummy available to match refer to interior sets. Escutcheon plates are also available with a privacy bolt (specify 106).

NEP plates not available with deadbolts.

### Styles

ET Traditional style  
EP Plain style  
ER Rectangular style

Escutcheon plate styles will cover a 2.1/8" cross bore hole. Heavy-duty, spring-loaded housings (X2124M) are included for added strength and durability (not supplied with knob sets).

### Door Thickness

Standard=1.3/4". For 1.3/8" doors or any other size, please specify.

### Backset

Standard=2.3/8". For 2.3/4" please specify.

### Passage Latch

1/2" throw with a 2.1/4" x 1" face plate. 8mm square hub size.

### Deadbolt Latch

1" throw with two hardened steel rods inside bolt for added security to resist sawing.

2.3/8" backset has a 2.1/4" x 1" face plate.

2.3/4" backset has a 2.1/4" x 1.1/8" face plate.

### Strike plates

Passage latch=T-strike 2.3/4" x 1.3/4" Lip size=1.1/4".

Deadbolt latch=2.3/4" x 1.1/8" heavy duty for wood and metal door jambs.

### Cross Bores

Passage and deadbolt latches fit any standard 2.1/8" cross bore hole.

Both latches require a standard 1" edge bore.

### Cylinder

Solid brass, 5-pin, mortise cylinder with C-keyway.

**Figure 6**  
Double Cylinder  
102 RP trim

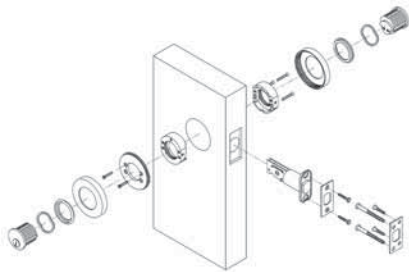

**Figure 7**  
Privacy Bolt 105  
RSP trim

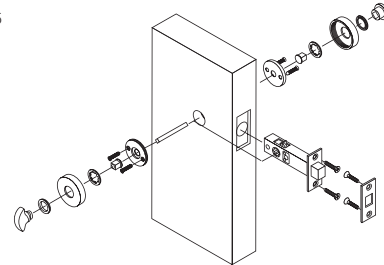

**Figure 8**  
Escutcheon with deadbolt  
103 EP trim

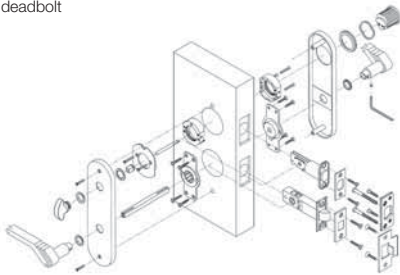

**Figure 9**  
Single Cylinder deadbolt 101

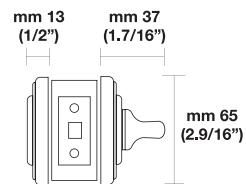

**Figure 10**  
Model Single Cylinder deadbolt  
101 RQ trim

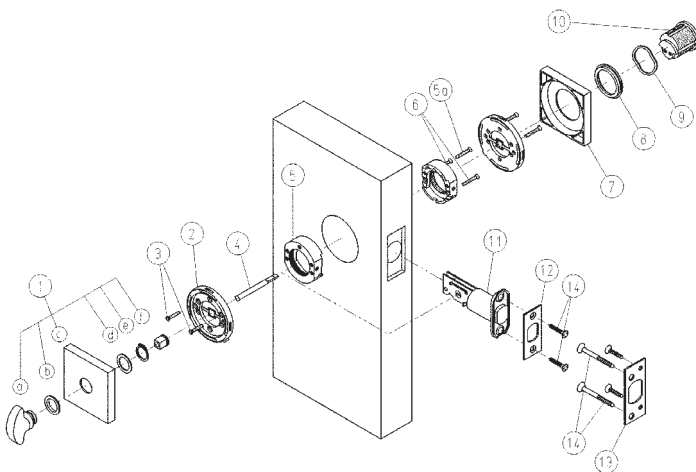

**Parts List**

1. Interior Rosette (1) includes:
  - a) thumbturn
  - b) nylon washer
  - c) rosette
  - d) metal washer
  - e) C-clip
  - f) nylon bushing
2. Under rosette (2)
3. 5/8" screws for under rosette (2)
4. Tailpiece (1)
5. Cylinder housing (1) includes 1.1/8" housing assembly screw
6. 1.1/8" cylinder housing screws (2)
7. Exterior rosette (1)
8. Cylinder collar (1)
9. Wave washer (1)
10. Cylinder with 2 keys (1)
11. Latch (1)
12. Face plate (1)
13. Strike plate (1)
14. Wood screws (6)
15. Allen wrench (not illustrated) (1)

# Mortise locks

Lever and Knob sets with rosette trim (specify RT, RP, RQ, RS) FIG.11 and 12.

Lever and Knob sets with long escutcheon trim (specify ET, EP, ER, NES) For figures refer on page 137/138.

## Trim definitions

RT	Traditional rosette trim	ET	Traditional escutcheon plate trim
RP	Plain rosette trim	ER	Rectangular escutcheon plate trim FIG.13
RQ	Square rosette trim	EP	Plain escutcheon plate trim
RS	Plain rosette trim (small)		
RSQ	Square rosette (small)		

## Door Thickness

Standard=1.3/4". For any other size, please specify.

## Backset FIG. 17B

2.1/2" or 2.3/4" standard, please specify.

NOTE: H function only available with long escutcheon plates. Custom backsets and other sizes are available upon special request.

## Narrow Backset

1.1/2", 1.3/4", 2", 2.1/4" available on request

## Latch Bolt

Solid brass with anti-friction latch, 3/4" throw, reversible.

Standard bolt finish is Satin Brass (03D), Satin Chrome (26D). Retract=28°

## Deadbolt

Brass with hardened steel inserts, 1" throw.

Standard bolt finish is Satin Brass (03D), Satin Chrome (26D).

## Lock Front

Adjustable bevel, brass or stainless steel armor front. Standard front=8" x 1.1/4". FIG. 17A

## Strike Plate

4.7/8" x 1.1/4" Curved lip FIG. 17C

## Door Preparation

ANSI Specifications, A115.1. Templates and instructions are provided for all functions.

## Cylinder

Solid brass, 5-pin, mortise cylinder with C-keyway.

## Handing

Please specify: RH, LH, RHR, LHR. Refer to handing chart on page 172.

## Performance Specifications

ANSI A 156.13, Grade 1, UL Listed, 3 hour fire rating.

## Case

Heavy gauge plated steel.

## Hubs

5/16" (8mm) square.

## Dust Box

Included.

Figure 11

ML F RQ trim

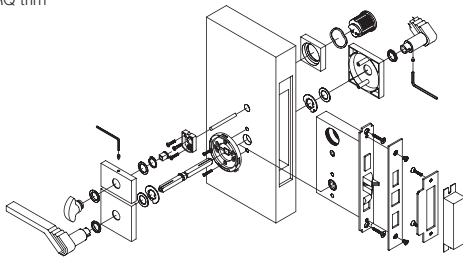

Figure 12

ML F RP trim

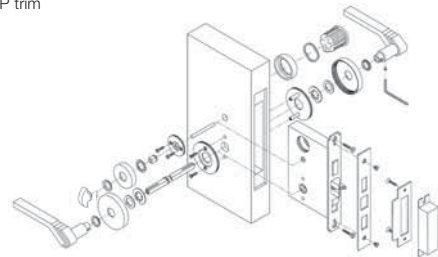
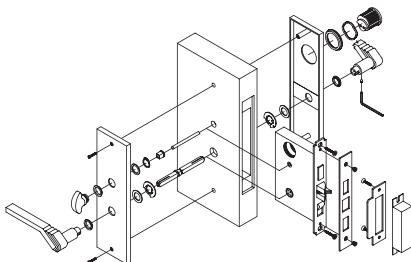

Figure 13

ML F ER trim



# Mortise locks

Figure 17A

Lock front

shown ML FD function

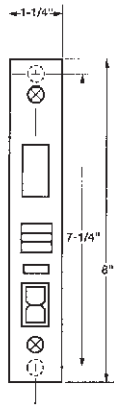

Figure 17B

Lock body

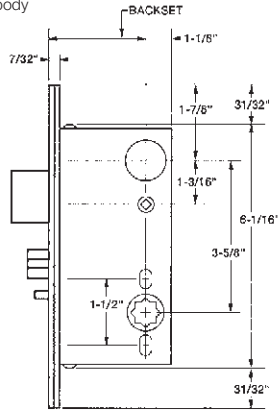
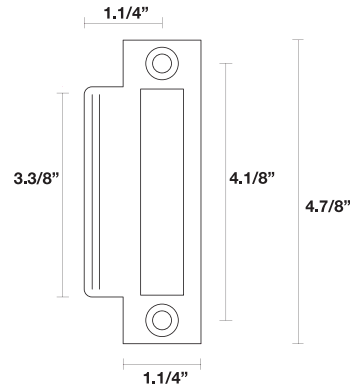
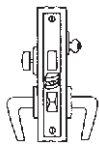

Figure 17C

Strike plate



## FUNCTIONS



### F ENTRANCE

Latch bolt by key outside and lever either side unless outside lever is locked by toggle-action stop. Dead bolt by key outside and turnpiece inside. Turning inside lever retracts latch and dead bolt simultaneously. Outside lever remains locked.

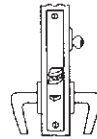

### EW STOREROOM - ELEC ELECTRIFIED

Latch by lever inside and key outside. Outside lever is always rigid. Auxiliary latch deadlocks latch bolt.

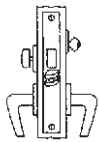

### FW ENTRANCE

Latch bolt by lever either side. Dead bolt by key outside and turnpiece inside. A turn of inside lever retracts latch and dead bolt simultaneously-automatically unlocking outside lever. No Toggle.

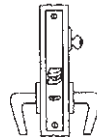

### J CLASSROOM

Latch bolt by key outside and lever either side unless outside lever is locked by key outside. Auxiliary latch deadlocks latch bolt.

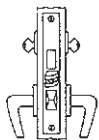

### AC ENTRANCE

Latch bolt by lever either side unless outside lever is locked by toggle action stop. Dead bolt by key either side.

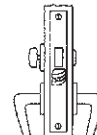

### LF PRIVACY

Latch bolt by lever either side. Dead bolt by turnpiece inside and coin key outside. A turn of inside lever retracts latch and dead bolt simultaneously-automatically unlocking outside lever.

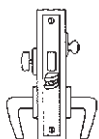

### B ENTRANCE

Latch bolt by lever either side. Dead bolt by key outside and thumbturn inside. No Toggle. No emergency egress.

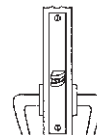

### N PASSAGE

Latch bolt by lever either side.

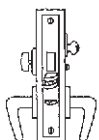

### H HOTEL

Latch bolt by lever inside and guest or master key outside. Outside lever always rigid. Dead bolt by turnpiece inside and key outside. A turn of inside lever retracts latch and dead bolt simultaneously. Auxiliary latch deadlocks latch bolt.

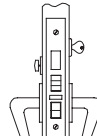

### ML FD ENTRANCE OR APARTMENT LOCK

Latch bolt by key outside and lever either side. Unless outside lever is locked by toggle-action stop. Dead bolt by key outside and turnpiece inside. Turning inside lever retracts latch and dead bolt simultaneously. Outside lever remains locked. Auxiliary latch deadlocks latch bolt and prevents manipulation of locked toggle action stop.

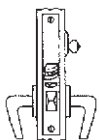

### E OFFICE

Latch bolt by key outside and lever either side unless outside lever is locked by toggle-action stop. Auxiliary latch deadlocks latch bolt.

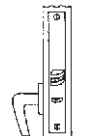

### NC COMMUNICATING

Latch bolt by lever one side.



# Mortise locks narrow backset

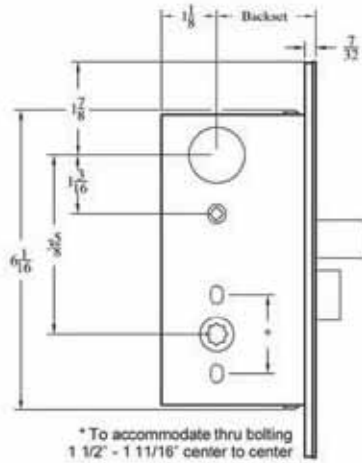

## FUNCTIONS

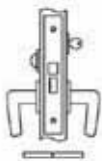

### ML FW Entrance

Latch bolt by lever either side.  
Dead bolt by key outside and turn piece inside.  
A turn of inside lever retracts latch and dead bolt simultaneously, automatically unlocking outside lever.



### ML F Entrance

Latch bolt by key outside and lever either side unless outside lever is locked by toggle action stop.  
Dead bolt by key outside and turn piece inside.  
Turning inside lever retracts latch and dead bolt simultaneously.  
Outside lever remains locked until manually unlocked by toggle.

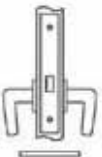

### ML N Passage

Latch bolt by lever either side.

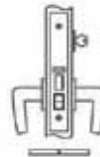

### ML E Office

Latch bolt by key outside and lever either side unless outside lever is locked by toggle-action stop.  
Auxiliary latch deadlocks latch bolt.

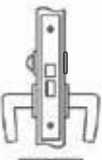

### ML LF Privacy

Latch bolt by lever either side.  
Dead bolt by turn piece inside and optional emergency key outside.  
A turn of inside lever retracts latch and dead bolt simultaneously—automatically unlocking outside lever.

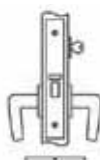

### ML EW Storeroom

Latch by lever inside and key outside.  
Outside lever always RIGID.  
Auxiliary latch deadlocks latchbolt.



### ML J Classroom

Latch bolt by key outside and lever either side unless outside lever is locked by key  
Auxiliary latch deadlocks latch bolt.



# Stainless steel door hardware

## STAINLESS STEEL DOOR HARDWARE - INTERIOR SETS

### Passage FIG. 18 (shown with RSS small rosette trim)

RSS, RPS, and RQS rosette trims are reversible for right and left handed doors.  
NES (narrow long escutcheon plates). Must specify door handing.  
NERS narrow long rectangular escutcheon plate multi point. Must specify door handing.

### Privacy FIG.s 19, 20, 21 (shown with RQS, ERS, NES trims)

RPS and RQS are reversible for right and left handed doors.  
Integral push button privacy features inside panic release function and outside emergency release.  
ERS rectangular escutcheon FIG. 20  
RSS (small rosette) trim is supplied with a privacy bolt (105 RSS).  
NERS Narrow long rectangular escutcheon plate multi point. Must specify door handing.  
NES (narrow long escutcheon plates) are supplied with a privacy bolt.  
NES (narrow long escutcheon plates). Must specify door handing.

### Dummy FIG. 22 (for RSS, RPS, ERS, RQS, NES trims)

Must specify door handing for single dummy.  
Surface mounted spindle (X0571) or opposing spindle (X0572) available.  
ERS/NES (narrow long escutcheon plates) with single dummy will have exposed mounting screws.  
Full dummy sets specified with R/L have exposed mounting screws on the interior only.

### Rosette Trim

RSS Plain style 2" (50mm) dia. (Not recommended for heavily used doors)  
RPS Plain style 2.9/16" (65mm) dia.  
RQS Square style 2.9/16" (65mm) dia.  
Please specify RPS, RQS or RSS for rosette.

### Long Escutcheon Plate Trim

NES Plain style (see page 137/138 for dimensions)  
NOTE: RSS (small rosettes) and NES (narrow long escutcheon plates) can only be used for new doors which do not have a 2.1/8" cross bore hole. Privacy sets require a separate privacy bolt.  
NERS Narrow long rectangular escutcheon plate multi point  
ERS Rectangular escutcheon plate

Heavy duty springs attached to the rosettes or escutcheons and levers provide added strength and durability (Not supplied with knob sets). All rosette trims have concealed mounting screws.

### Door Thickness

Standard = 1.3/4". For any other size, please specify.

### Backset

Standard = 2.3/8". For 2.3/4" please specify.

### Cross Bore

RPS, RQS rosette, ERS escutcheon trim fits in any standard 2.1/8" cross bore hole with a 1" edge bore.  
RSS, RSQS rosettes and NES narrow long escutcheon plates require a 1/2" cross bore hole.

### Latch Bolt

1/2" throw with 2.1/4" x 1" face plate. 8mm square hub size.

### Dust Box

Included.

### Strike Plate

Standard = T-strike 2.3/4" x 1.3/4". Lip size = 1.1/4"  
Full lip strikes are available upon special request.  
Square corner.

NOTE: Face plate, T-strike and screws are solid brass plated in satin nickel (15) or polished chrome (26) finishes.

**Figure 18**  
Passage Function  
RSS trim

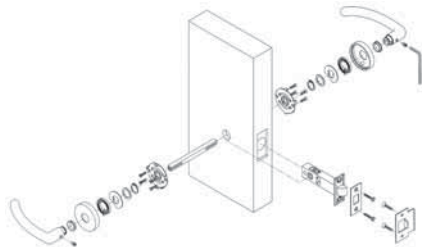

**Figure 19**  
Privacy Function  
RQS trim

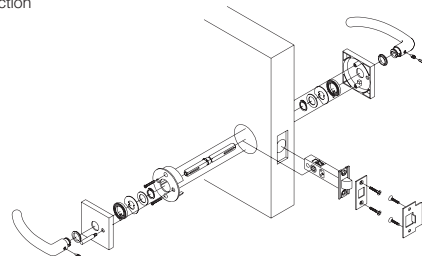

**Figure 20**  
Privacy Function  
ERS trim

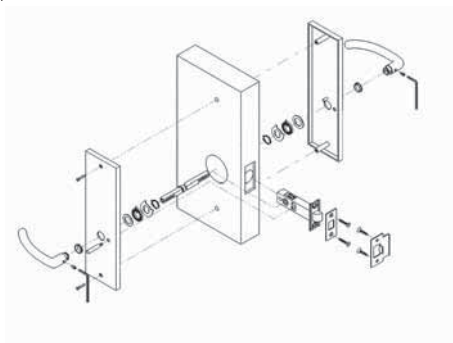

**Figure 21**  
Privacy Function  
NES trim

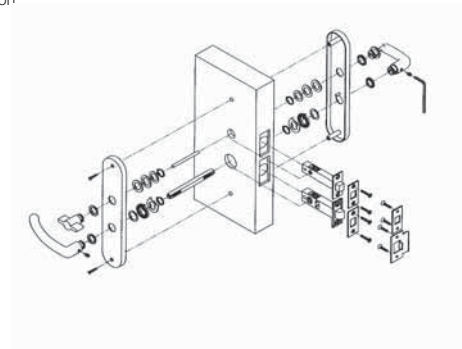

**Figure 22**  
Dummy trim

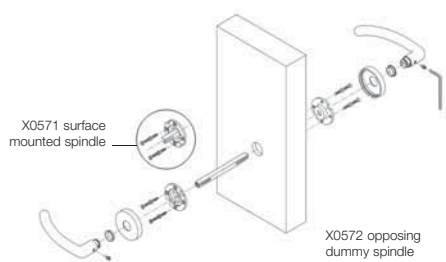

# Stainless steel door hardware

## STAINLESS STEEL DOOR HARDWARE - EXTERIOR SETS

### Privacy Bolt FIG. 23

105 RSS, 105 RSQS = Thumbturn and emergency release trim with latch bolt.

105 RSS L/E, 105 RSQS L/E = Thumbturn with latch bolt. (no exterior trim)

Decorative thumbturn with coin key emergency release on exterior. Includes concealed mounting screws.

### Deadbolts FIG. 24

Single Cylinder (101 RPS, 101 RQS)

Double cylinder (102 RPS, 102 RQS)

Features low profile trim (see FIG.9 on page 182) designs, which coordinate with all of our stainless steel lever and knob styles. Includes concealed mounting screws.

### Door Thickness

Standard = 1.3/4". For any other size please specify.

### Mortise Locks

FIG. 25 (ERS trim) FIG. 26 (RPS trim) FIG. 27 (NES trim)

For mortise lock specifications and lock information, please see page 183-184.

Face and strike plates are satin stainless steel for 32D finish.

Polished stainless steel (32) finish uses a chrome plated solid brass lock front and strike plate.

Mortise lock trim is designed to fit most mortise lock manufacturers.

Please call factory for more information.

### Rosette Trim

RSS Plain style 2" (50mm) dia. (not recommended for heavily used doors).

RPS Plain style 2.9/16" (65mm) dia.

RSQS Square style 1.3/4" (45mm) (not recommended for heavily used doors).

RQS Square style 2.9/16" (65mm) dia.

### Long Escutcheon Plate Trim

NERS Narrow rectangular escutcheon (see page 156 for dimensions)

NES Narrow plain style (see page 137/138 for dimensions)

ERS Rectangular style (see page 137/138 for dimensions)

### Door Thickness

Privacy Bolt - Standard = 1.3/4". For 1.3/8" or larger than 1.3/4, please specify.

Deadbolt - Standard = 1.3/4". For 1.3/8" or larger than 1.3/4", please specify.

Mortise Lock - Standard = 1.3/4" For 1.3/8" or larger than 1.3/4", please specify.

For any other sizes, please specify.

### Backsets

Privacy Bolt - Standard = 2.3/8". For 2.3/4" please specify.

Deadbolt - Standard = 2.3/8". For 2" or 2.3/4" please specify.

Mortise Locks - Must specify 2.1/2" or 2.3/4". Additional sizes are available upon request.

### Door Preparation

Privacy Bolt requires a 5/8" cross bore hole with a 1" edge bore hole.

Deadbolt requires a standard 2.1/8" cross bore hole with a 1" edge bore hole.

Mortise Locks. Templates and instructions are provided for all functions.

### Cylinders

Solid Brass, 5-pin, mortise cylinder with C-keyway.

### Dust Box

Included.

For more technical information please see the following pages:

Privacy Bolts - page 181

Deadbolts - page 181

Mortise Locks - page 183-184

Figure 23  
Privacy Bolt  
105 RSQS

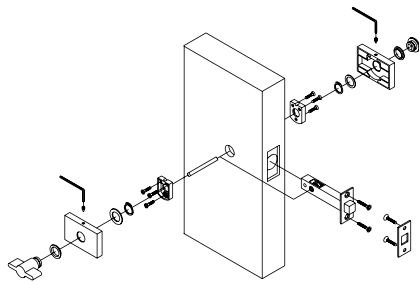

Figure 24  
Deadbolt Single Cylinder  
101 RPS

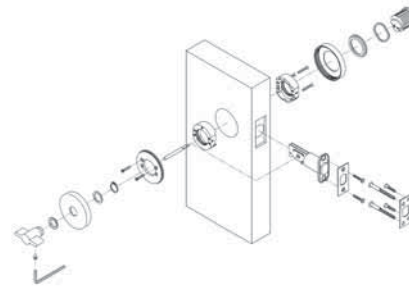

Figure 25  
ML F  
ERS trim

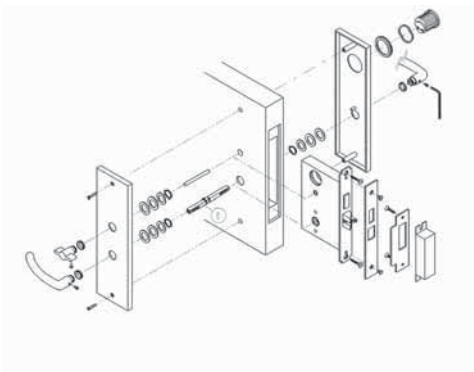

Figure 26  
ML F  
RPS trim

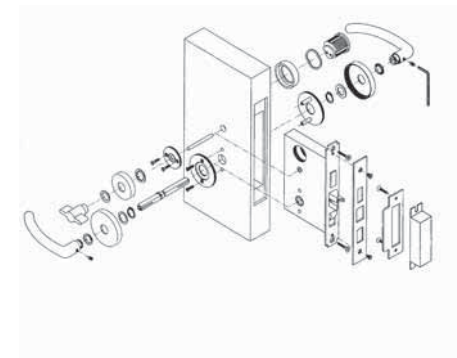
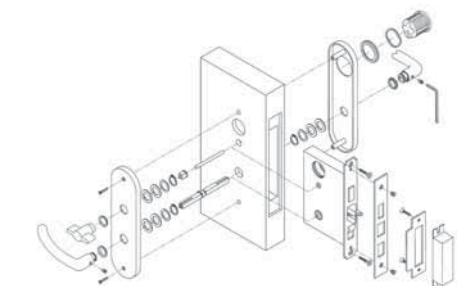

Figure 27  
ML F  
NES trim



# Multi-Point hardware

## Trim Options

- RSM Plain style rosette, 1.3/4" (45mm) dia. Solid brass. FIG. 31
  - RSSM Plain style rosette, 2" (50mm) dia. Stainless steel. Available in 32D finish only.
  - NEP Narrow long escutcheon plates. Solid brass.
  - NER Narrow long rectangular escutcheon plate. Solid brass.
  - NERS Narrow long rectangular escutcheon plate. Stainless steel. Available in 32D finish only.
  - NES Narrow long escutcheon plates. Stainless steel. Available in 32D finish only.
- RSM and RSSM trims include a profile cylinder with coordinated rosettes. For NEP/NES specifications see page 156.

## Functions

- EAB Entry function with American cylinder below the lever, 92mm center to center. FIG. 28
- PAB Patio function with the interior thumbturn below the lever, no keyway on the exterior plate.
- EAA Entry function with American cylinder above the lever, 92mm center to center. FIG. 29
- PAA Patio function with the interior thumbturn above the lever, no keyway on the exterior plate.
- EE Entry function with profile cylinder, 92mm center to center. FIG. 30
- PE Patio function with 1/2 profile cylinder & thumbturn, no keyway on the exterior plate.
- CE Custom entry function with special center to center sizes. Uses a profile cylinder.
- DA Active dummy pair.
- DS Single dummy, surface mounted spindle.

## Door Thickness

Standard = 1.3/4". We can also accommodate 2.1/4". Please call factory.

## Cylinders

Profile and American type cylinders are all solid brass construction, 5-pin with C-keyways.

## Spindle

8mm square.

## Handing

Handing is required for all multi-point hardware. Please specify RH or LH. Refer to the handing chart on page 172.

## Finishes

RSM and NEP trims are stocked in polished brass (03) and satin nickel (15) finishes.  
 NER trim stocked in polished chrome (26) and satin chrome (26D).  
 Custom finishes are available upon special request. Call factory for quotation.  
 RSSM, NES and NERS trims are stocked in satin stainless steel (32D) only. No custom plating on any stainless steel products.

**Figure 28**  
Entry EAB Function  
NEP trim

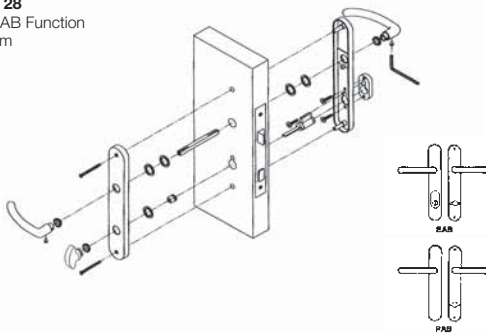

**Figure 29**  
Entry EAA Function  
NEP trim

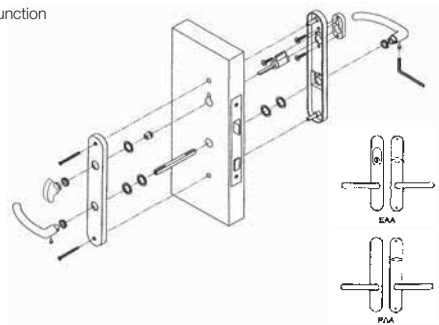

**Figure 30**  
Entry EE Function  
NEP trim

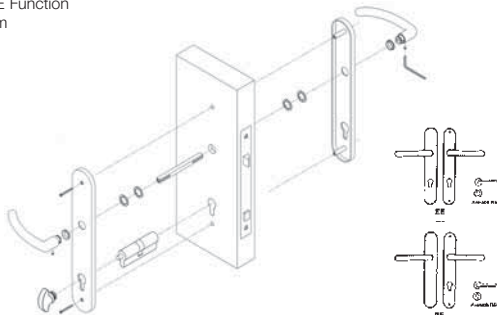

**Figure 31**  
Entry EE Function  
RSM trim

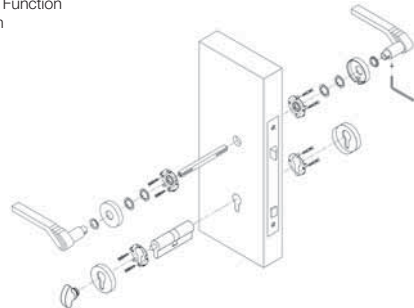

# Narrow long escutcheon plates

## INTERIOR SETS

**Passage** FIG.34 (shown with NES plates)  
Must specify handing.

**Privacy** FIG.35 (NES trim) and FIG.36 (NEP trim)  
Must specify handing.

Privacy function uses a privacy bolt. Integral privacy is not available with NEP or NES trim plates.  
NOTE: NEP privacy bolt is below the lever. FIG. 36. NES privacy bolt is above the lever. FIG. 35.

**Dummy** FIG.37 and FIG.38

Must specify handing. Surface mounted spindles (X0571) for NES and (X0571 DMY SQ) for NEP.  
Opposing dummy spindle available for NES, NEP (X0572). NEP and NES plates with a single dummy will have exposed mounting screws. Full dummy sets specified with R/L have exposed mounting screws on the interior only.

### Trim Options

- NEP Narrow long escutcheon plates. Solid brass. For specifications see page 156.
- NES Plain long narrow escutcheon plates. Stainless steel. For specifications see page 156.
- NER Narrow long rectangular escutcheon plate. Solid brass. For specifications see page 156.
- NERS Narrow long rectangular escutcheon plate. Stainless steel. For specifications see page 156.

### Door Thickness

Standard = 1.3/4". For any other size, please specify.

### Backset

Standard = 2.3/8". For 2.3/4" please specify.

### Latch Bolt

1/2" throw with 2.1/4" x 1" face plate. 8mm square hub size (tubular latch).

### Strike Plate

Standard = T-strike 2.3/4" x 1.3/4". Lip size = 1.1/4" (tubular latch)

Full lip strikes are available upon special request. Square corner.

**Figure 34**

Passage Function  
NES trim

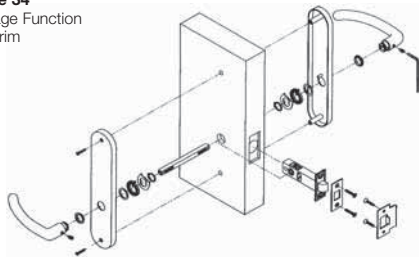

**Figure 35**

Privacy Function  
NES trim

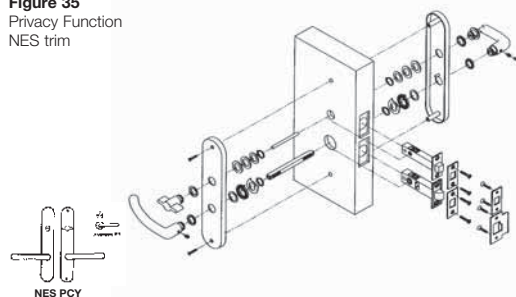

**Figure 36**

Privacy Function  
NEP trim

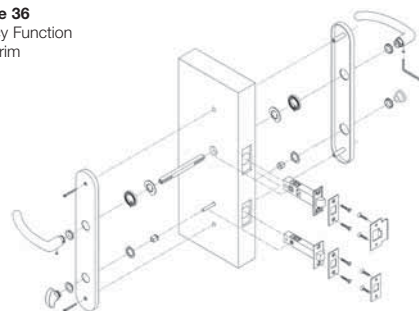

**Figure 37**

Dummy Single  
NEP trim

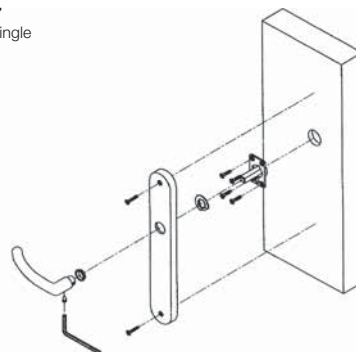

**Figure 38**

Dummy Pair  
NES trim

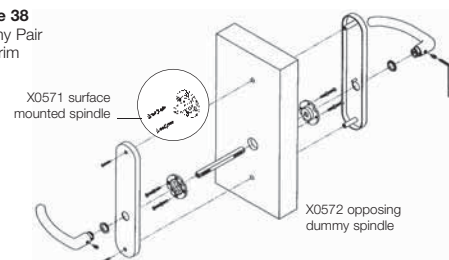



# Installation templates

TRIM: RP - RT - RPS - RQ - RQS

**Valli&Valli** (U.S.A.) INC.

## ROUND ROSETTE LOCKSET AND DEADBOLT INSTALLATION TEMPLATE

### IMPORTANT NOTE

If door is beveled, place template on low side of door bevel. Determine before drilling, length of latch enclosed for proper backset installation. Read instruction sheet before installing lock.

Mark proper center for 2.1/8" diameter cross bore hole according to lockset requirement.

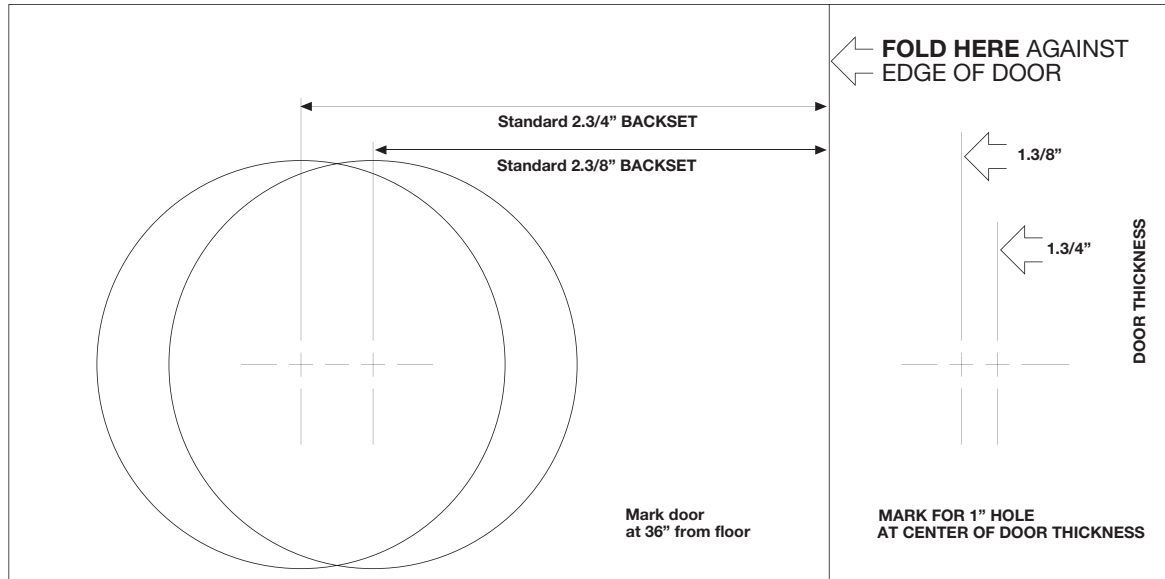

TRIM: RS - RSS - RSQS - 105

**Valli&Valli** (U.S.A.) INC.

## ROUND ROSETTE LOCKSET INSTALLATION TEMPLATE

### IMPORTANT NOTE

If door is beveled, place template on low side of door bevel. Determine before drilling, length of latch enclosed for proper backset installation. Read instruction sheet before installing lock.

Mark proper center for 5/8" diameter cross bore hole according to lockset requirement.

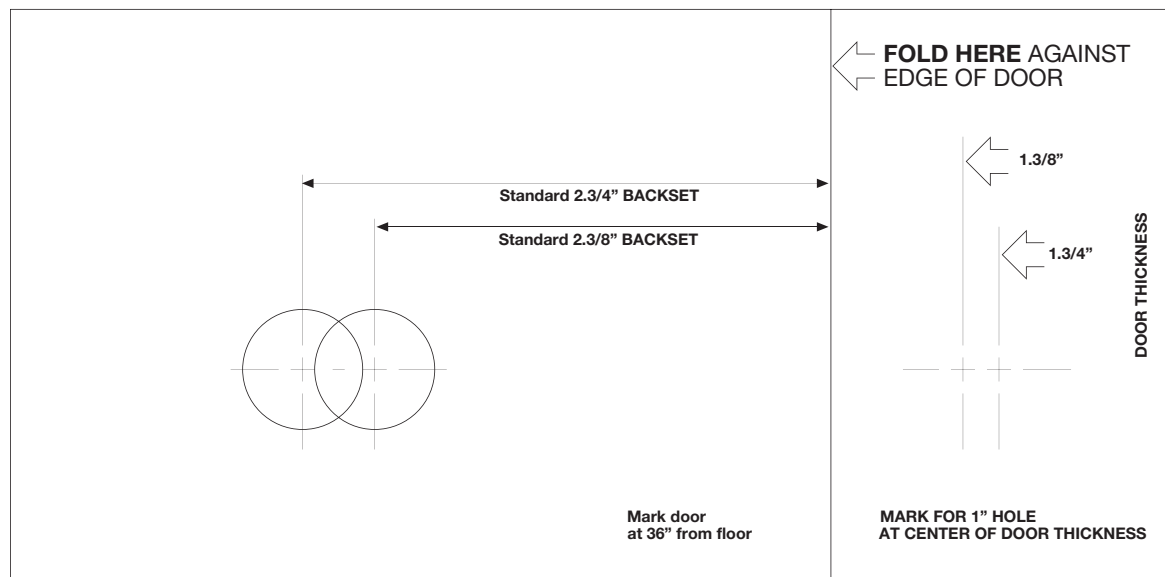



ML-N	9125	ML-E	9156	ML-AC	9122	ML-F	9148	ML-LF	9139	ML-ELEC	9159ELEC
ML-EW	9159	ML-J	9145	ML-FW	9124	ML-FD	9167				

FIND CATALOG NUMBERS IN FIGURES ABOVE WHICH INDICATE THE TYPE OF HANDLE AND LEVER TO COMPARE TEMPLATE ABOVE FOR ADDITIONS AND FILE SIZES

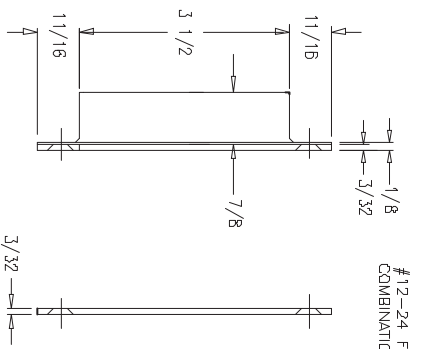
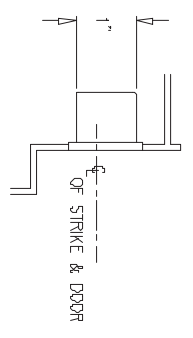
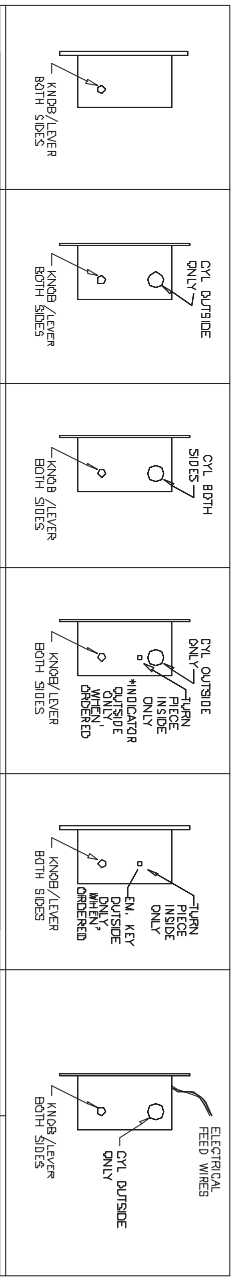

DOOR AND FRAME MANUFACTURERS ARE RESPONSIBLE FOR PROVIDING ADEQUATE CONSTRUCTION OR REINFORCEMENTS FOR PROPER INSTALLATION OF HARDWARE SHOWN.

NOTE  
MFG. FURNISHED  
ONLY WHEN  
ORDERED

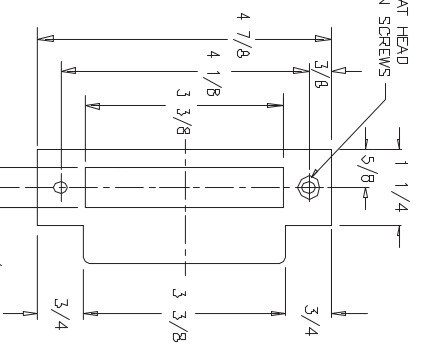

**TEMPLATE  
ML SERIES  
2 1/2 BACKSET**

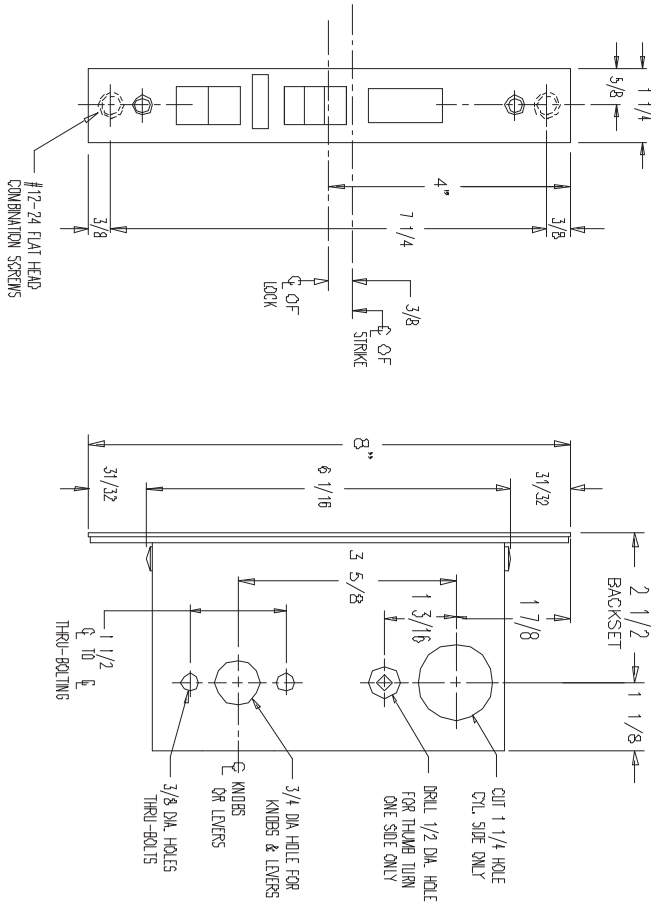
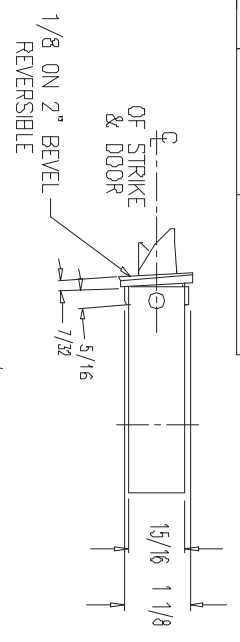

SCALE: 1=2.7815

# Valli & Valli (U.S.A) Inc.

Manufactures of  
Custom Locks and Architectural Hardware

## ML-9500 - 2 3/4 Backset Dead Bolt Lock Installation Template

ML-9501	9501	ML-9502	9502	ML-9503	9503
<p>1 1/4 Cylinder Outside Only</p>		<p>1 1/4 Cylinder Both Sides</p>		<p>1 1/4 Cylinder Outside Only 5/8 Turn Piece Inside Only</p>	

Find Catalog Numbers Which Will Show Cutouts For Functions Desired. Refer To Composite Template Above For Locations And Sizes Of Holes.

**Responsibility**  
Door And Frame Manufacturers Are Responsible For Providing Adequate Construction Or Re-Inforcement For Proper Installation Of Hardware Shown.

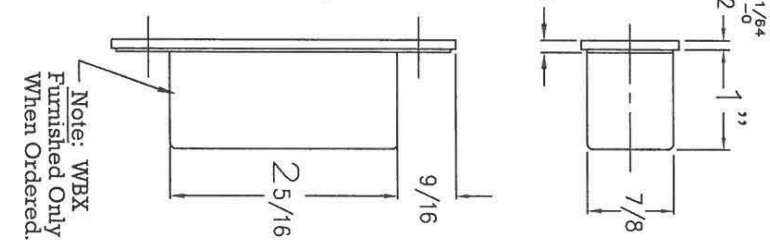
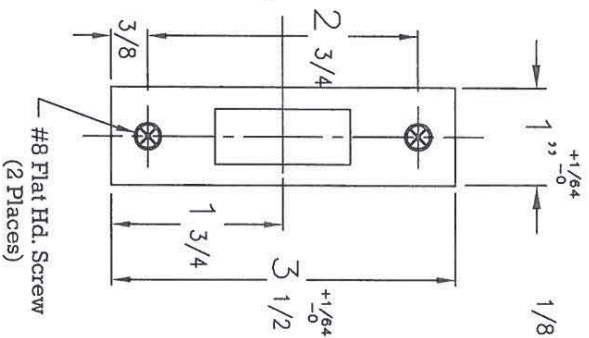
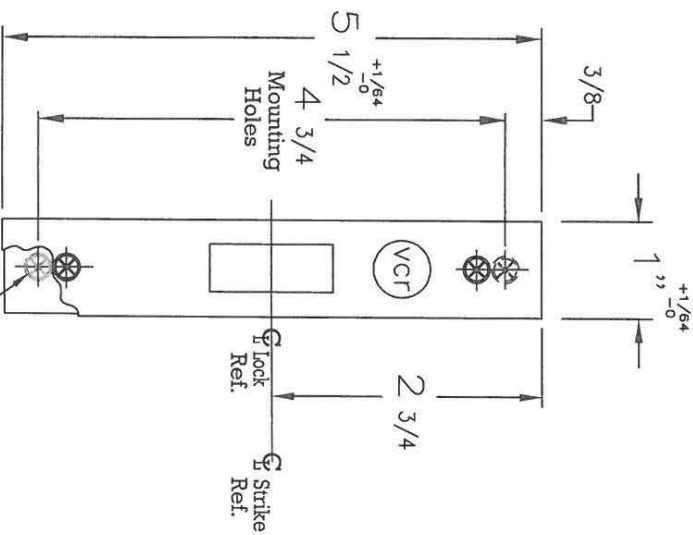
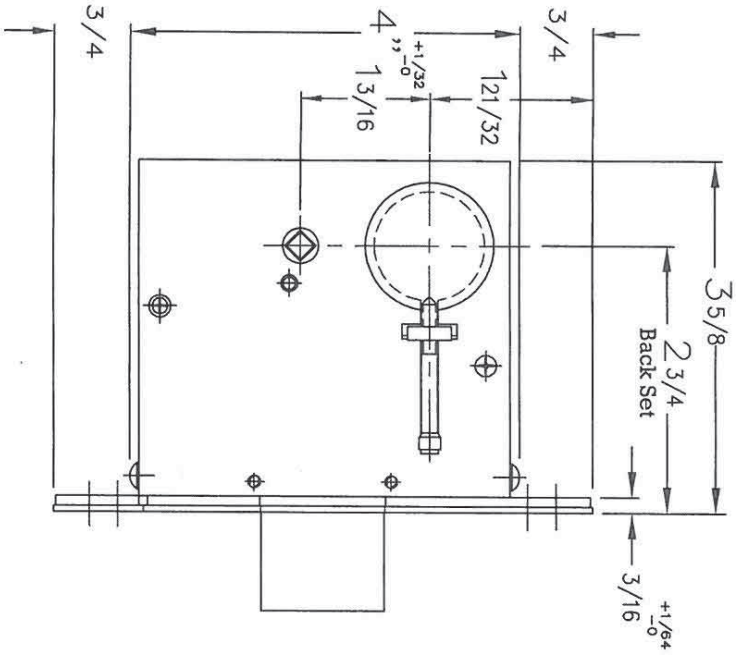
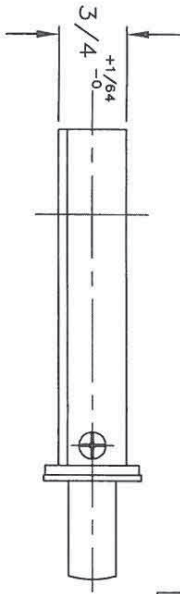

Mounting #8 Flat Hd. Screw (2 Places)

Note: WBX Furnished Only When Ordered.

# List of door thickness

# List of door thickness for each door lever

**DOOR HANDLES**

Article	Series	Thickness from	to	with spindle
H 163	Sarissa	33 mm	55 mm	8 x 114 mm
H 165	Germana	33 mm	53 mm	8 x 114 mm
H 174	Altair	33 mm	50 mm	8 x 114 mm
H 176	Spiga	33 mm	55 mm	8 x 114 mm
H 179	Aida	33 mm	55 mm	8 x 114 mm
H 192	Prunus	33 mm	55 mm	8 x 114 mm
H 195	Orchidea	33 mm	55 mm	8 x 114 mm
H 198	Mizar	33 mm	55 mm	8 x 114 mm
H 412	Lilla	33 mm	57 mm	8 x 114 mm
H 413	Millennium	33 mm	57 mm	8 x 114 mm
H 414	Amber	30 mm	60 mm	8 x 114 mm
H 415	Scarlet	30 mm	60 mm	8 x 114 mm
H 416	Garnet	30 mm	60 mm	8 x 114 mm
H 417	Indigo	30 mm	60 mm	8 x 114 mm
H 418	Azure	30 mm	60 mm	8 x 114 mm
H 419	Bordeaux	30 mm	60 mm	8 x 114 mm
H 421	Didone	33 mm	60 mm	8 x 114 mm
H 1003	Croco	33 mm	55 mm	8 x 114 mm
H 1004	Antares	37 mm	43 mm	8 x 96 mm
H 1012	Poliuto	33 mm	55 mm	8 x 114 mm
H 1015	West	33 mm	55 mm	8 x 114 mm
H 1016	Nabucco	37 mm	57 mm	8 x 104 mm
H 1017	Camelia	33 mm	57 mm	8 x 114 mm
H 1018	Otello	33 mm	57 mm	8 x 114 mm
H 1022	Ernani	37 mm	55 mm	8 x 114 mm
H 1024	Lolita	30 mm	55 mm	8 x 114 mm
H 1026	Dido	33 mm	48 mm	8 x 96 mm
H 1027	Dafne	33 mm	55 mm	8 x 114 mm
H 1034	Polis	35 mm	65 mm	8 x 114 mm
H 1037	Teseo	38 mm	50 mm	8 x 104 mm
H 1038	Armida	35 mm	57 mm	8 x 114 mm
H 1039	Fedra	27 mm	54 mm	8 x 104 mm
H 1042	Walkiria	33 mm	62 mm	8 x 114 mm
H 1043	Alcina	35 mm	64 mm	8 x 114 mm
H 1044	Oberon	40 mm	55 mm	8 x 104 mm
H 1045	Bess	36 mm	62 mm	8 x 114 mm
H 1046	Nais	32 mm	63 mm	8 x 114 mm
H 1048	Orione	33 mm	55 mm	8 x 114 mm
H 1049	Divara	33 mm	60 mm	8 x 114 mm
H 1050	Giasone	32 mm	63 mm	8 x 114 mm
H 1051	Tieste	32 mm	63 mm	8 x 114 mm
H 4705	Rhodamine	33 mm	60 mm	8 x 114 mm
H 4707	Grey	33 mm	60 mm	8 x 114 mm
H 4730	White	32 mm	63 mm	8 x 114 mm
H 4734	Magenta	32 mm	63 mm	8 x 114 mm
H 4742	Coral	37 mm	50 mm	8 x 104 mm
H 4744	Artica	32 mm	63 mm	8 x 114 mm

# UNI EN ISO 9001:2008

# Quality



www.icim.it

CERTIFICATO n. **0492/5**  
CERTIFICATE No. \_\_\_\_\_

SI CERTIFICA CHE IL SISTEMA DI GESTIONE PER LA QUALITÀ DI  
WE HEREBY CERTIFY THAT THE QUALITY MANAGEMENT SYSTEM OPERATED BY

**ASSA ABLOY Italia S.p.A.**  
UNITÀ OPERATIVE  
OPERATIVE UNITS

**Sede e Unità Operativa**  
Via Bovaresa, 13 - 40017 San Giovanni in Persiceto (BO)  
**Unità Operativa**  
Strada del Mescolin, 62 - 31016 Cordignano (TV)  
Via Concordia, 16 - 20838 Renate (MB)  
Italia

E' CONFORME ALLA NORMA  
IS IN COMPLIANCE WITH THE STANDARD

**UNI EN ISO 9001:2008**

PER LE SEGUENTI ATTIVITÀ  
FOR THE FOLLOWING ACTIVITIES

**EA: 17 - 23e**

Progettazione, produzione, vendita e commercializzazione di serrature  
meccaniche, elettriche ed elettroniche; chiavi, cilindri, lucchetti, maniglioni  
antipanico e chiudiporta. Progettazione e produzione di maniglie e  
coordinati per l'arredamento.

*Design, production, sale and trade of: mechanical, electrical and electronic  
locks; keys, cylinders, locks, panic exit devices and door closers. Design  
and manufacturing of handles and sets for furnishings*

Riferirsi al Manuale della Qualità per l'applicabilità dei requisiti della norma di riferimento.  
Refer to Quality Manual for details of application to reference standard requirements.

Il presente certificato è soggetto al rispetto del regolamento per la certificazione dei sistemi di gestione per la qualità delle aziende.  
The use and the validity of this certificate shall satisfy the requirements of the rules for the certification of company quality management systems.

Data emissione First issue	Emissione corrente Current issue	Data di scadenza Expiring date
25/03/1996	02/08/2011	05/03/2014

  
**ICIM S.p.A.**  
Piazza Don Enrico Mattei, 75 - 20090 Sesto San Giovanni (MI)



ACCREDIA  
SISTEMI DI ACCREDITAMENTO

ISO 9001:2008  
SUA 9001  
SUA 9002

Numero degli Accordi di Mutual Recognition: 8 A, 14 F e 14 AC  
Signatories of 8 A, 14 F and 14 AC Mutual Recognition Agreements



FEDERAZIONE  
CISQ

www.cisq.com

## Quality trade-marks/Marchi di qualità



**ICILA**

ISO 9001:2000  
Cert./ Zertifikat n. 77

Institute for the Certification  
of Quality in the Wood and  
Decorative Industries

Istituto per la Certificazione di  
Qualità delle Industrie del Legno  
e dell'Arredamento



Italian Certification  
of Quality Systems

Certificazione Italiana  
dei Sistemi di Qualità



ISO 9001:2000  
Cert./ Zertifikat n.  
IT-2528 International Quality  
Network



All Valli & Valli USA inc  
Levers meet ADA  
accessibility requirements





# General sales terms and conditions

# General sales terms and conditions

All orders are accepted subject to the following Terms and Conditions of Sale. Any terms and/or conditions contained in the Buyer's purchase order or other writing pertaining to such order which are in conflict with or add to or subtract from the following Terms and Conditions of Sale shall not become part of any resulting contract unless expressly accepted in writing by Valli & Valli (U.S.A.) Inc. ("V&V").

## 1. GENERAL INFORMATION

- (a) V&V reserves the right to accept or reject any order for any reason.
- (b) No order is binding on V&V until received in writing and approved by V&V. V&V agrees to sell and Buyer agrees to buy only in accordance with these terms and conditions which are applicable to and binding upon the sale and purchase of every product sold by V&V. No departure from these terms and conditions in any respect whatsoever shall be valid except when in writing and signed by an authorized officer of V&V. Any additions, deletions or other changes to or in an order are subject to the terms and conditions stated herein. No salesman or agent of V&V has the authority to make any changes in V&V's terms and conditions or sale prices.
- (c) V&V shall deliver the products specified on an order within a reasonable time after acceptance of orders, and shall use reasonable efforts to make timely delivery subject to the ability of V&V to ship, at the time and in the quantity specified, contingent upon strikes, floods, fires, accidents, labor or material troubles, product availability, or rules and regulations of the United States or any state, municipal or other lawful authority therein or where V&V's products are manufactured, or other causes beyond the control of V&V, and V&V shall not be liable for damages for failure to make partial or complete shipment or for any delay in making shipments. In no event shall the terms of this provision affect Buyer's obligation to pay for goods sold and delivered.
- (d) The Buyer may not cancel an order without V&V's consent. If V&V is unable to make shipment of specified quantities of its standard products within thirty (30) days of the specified time and so notifies the Buyer, the Buyer may give notice to V&V by telefax confirmed by letter sent registered mail of its intention to cancel that part of the order which remains unshipped at the time of V&V's receipt of such telefax or within fifteen (15) days after the post-marked date of such letter, whereupon such unshipped part of the order shall be cancelled.
- (e) All specifications listed in our Catalog and/or Price List are subject to change without notice including packing, weights, measurements and product designs.

## 2. PRICES

- (a) Prices are quoted, products are sold, and all shipments are made F.O.B. V&V's warehouse, unless otherwise specified. All prices are stated in U.S. currency.
- (b) Each order, or any part thereof, is subject to billing and payment at V&V's prices in effect at the time of shipment.
- (c) V&V reserves the right to change any of the prices of an order up to the date of shipment, upon notice to the Buyer. Any orders upon which prices have been changed which are not confirmed by Buyer within fifteen (15) days of notice being sent shall be cancelled.
- (d) All prices are subject to additional federal, city and state taxes, if applicable.
- (e) Prices, terms and conditions of sale, and trade discounts, if any, are subject to change without prior notice at any time prior to V&V's acceptance of the Buyer's order.

## 3. TERMS OF PAYMENT

- (a) Terms of payment are thirty (30) days net from the date of V&V's invoice and payment is not timely unless actually received by V&V on or before the due date.
- (b) A service and carrying charge of one and one half (1-1/2%) percent per month (annual percentage rate eighteen (18%) percent) will be charged on all invoices outstanding more than thirty-five (35) days. Buyer shall pay all costs and expenses (including reasonable attorney's fees) incurred by V&V in connection with any payments not made when due. V&V reserves the right to stop confirmed shipments to accounts which have invoices over sixty (60) days past due.
- (c) If Buyer fails to pay an invoice at maturity or defaults on or repudiates this or any other agreement with V&V, or becomes insolvent or calls a meeting of its creditors or if a bankruptcy, insolvency, re-organization or arrangement proceeding is commenced by or against Buyer, V&V may (i) cancel this and/or any other contracts with Buyer, and Buyer shall remain liable for any damages to V&V; or (ii) (a) declare all outstanding invoices under this and/or any other contracts immediately due and payable; (b) defer any shipments hereunder; (c) sell all or part of the undelivered goods at private or public sale, at which V&V may become buyer; (d) bill at contract price all or any part of the undelivered goods to Buyer, with delivery to Buyer only after full payment is made; and (e) take possession of delivered but unpaid for goods wherever found without process of law.
- (d) If, at any time, reasonable grounds for insecurity arise with respect to Buyer's performance of its payment obligations to V&V. V&V may demand payment in full for the products or such financial security which in V&V's sole discretion shall be equivalent to the sales price of the products.

## 4. RUSH DELIVERY CHARGES \$ 25.00 NET

Applies to all orders requested to be shipped within 48 hrs.

## DROP SHIP CHARGES \$ 5.00

## 5. SHIPPING AND FREIGHT ALLOWANCE

V&V will ship products in any manner most satisfactory to V&V, based upon convenience, experience and cost. Full freight allowed and prepaid to all points in the continental United States on any shipment equal to or in excess of One Thousand (\$1,000.00) Dollars net invoice value by the carrier of V&V's selection.

No freight allowance on shipments of less than One Thousand (\$1,000.00) Dollars net invoice value. A One (\$1.50) Dollar fifty cent service charge per shipment shall be applied for freight handling and insurance coverage.

## 6. RETURNS

A written request must be received by V&V and approved by an authorized officer of V&V in writing prior to the return of any products. Any approved returns shall be delivered at Buyers expense freight prepaid to any point designated by V&V and a minimum of thirty-five (35%) percent handling charge will apply. A handling fee will be charged on all returned goods. All returned goods must be returned in the original factory sealed cartons and must be in saleable condition. Merchandise may be returned for credit toward future orders only. Credit must be applied within one (1) year of the date of issuance.

## 7. CLAIMS

Risks of theft, loss or damage to, or destruction of, the products shall pass to the Buyer when the products are placed in the possession of the first carrier at V&V's place of shipment. Claims for damage, loss in transit and delay in delivery must be made to the carrier by the Buyer. All other claims must be reported promptly within fifteen (15) days of receipt of merchandise. Replacement deliveries shall be made or returns accepted only if V&V's investigation supports the claim. V&V's liability with respect to substantiated claims shall be limited to either replacing or accepting the return of the products with refund of the original purchase price.

## 8. LIMITED WARRANTY

V&V warrants to third party purchasers that V&V products shall be free from defects in material or workmanship for a period of one (1) year following their purchase from an authorized V&V dealer. V&V's sole obligation under this warranty shall be to repair or replace products which V&V determines to be defective and which are returned to V&V with proper documentation during the warranty period, shipping charges prepaid to 100 Commerce Way, Suite 2, Hackensack, NJ 07601.

V&V DOES NOT ASSUME ANY WARRANTY RESPONSIBILITY FOR DAMAGES DUE TO CONDITIONS OVER WHICH V&V HAS NO CONTROL, INCLUDING BUT NOT LIMITED TO IMPROPER INSTALLATION, IMPACT, TAMPERING OR ABUSE. FINISHES CANNOT BE GUARANTEED FROM TARNISHING, EXCESSIVE WEAR, OR DETERIORATION DUE TO EXPOSURE TO ATMOSPHERIC CONDITIONS OVER WHICH V&V HAS NO CONTROL. V&V MAKES NO OTHER WARRANTIES, EXPRESS OR IMPLIED, WITH RESPECT TO THE PRODUCTS DELIVERED, INCLUDING WITHOUT LIMITATION, ANY WARRANTY OF MERCHANTABILITY OR FITNESS FOR A PARTICULAR PURPOSE. IN NO EVENT SHALL V&V BE LIABLE FOR ANY SPECIAL, INDIRECT, INCIDENTAL OR CONSEQUENTIAL DAMAGES INCLUDING, BUT NOT LIMITED TO, LOSS OF PROFITS OR DAMAGES TO BUSINESS OR BUSINESS RELATIONS.

THIS WARRANTY IS IN LIEU OF ALL OTHER WARRANTIES EXPRESS OR IMPLIED, STATUTORY OR OTHERWISE AND IS LIMITED TO THE DURATION OF THE WARRANTY PERIOD OF THIS EXPRESS WARRANTY. SOME STATES DO NOT ALLOW LIMITATION ON HOW LONG AN IMPLIED WARRANTY LASTS OR THE EXCLUSION OR LIMITATION OF INCIDENTAL OR CONSEQUENTIAL DAMAGES SO THE ABOVE LIMITATIONS OR EXCLUSIONS MAY NOT APPLY TO BUYER. THIS WARRANTY GIVES YOU SPECIFIC LEGAL RIGHTS AND BUYER MAY ALSO HAVE OTHER RIGHTS WHICH VARY FROM STATE TO STATE.

## 9. GOVERNING LAWS

Any controversy or claim arising out of or relating to the purchase or sale of V&V's products shall be construed in accordance with the laws of the State of New York and shall be settled by arbitration in the City, Country and State of New York in accordance with the current Commercial Arbitration Rules of the American Arbitration Association and judgment upon the award rendered may be entered in any court of competent jurisdiction.

## 10. SIZES AND DIMENSIONS

Conversion from metric to U.S. measurements is approximate. Refer to product for exact metric sizing.

## 11. PROJECTS

All project orders require a down payment. **Freight FOB New Jersey Warehouse.**

## 12. DISCONTINUED

We can discontinue products or alter specifications at any time without prior notification or obligation. Product will continue to be available as long as inventory remains, after which the product will be discontinued. This program is intended to help our customers anticipate future needs and to avoid bidding or taking orders on parts which may not be available in sufficient quantities when needed.

## 13. INDUSTRY STANDARD

The prevailing industry standard is that the special order items, electrical products and specialty keyed products may not be returned.

## 14. INSTRUCTIONS

Door handles and their accessories are designed to open and close doors. They represent a complimentary element of the door, together with the frame, hinges, door panel, lock and cylinder.

Opening and closing a door with a handle requires certain actions, such as opening a security bolt.

Only in certain cases, such as on emergency doors, the handles serves the function of working the lock by lowering or pushing it.

Window handles too are to be considered only a complimentary part of the window. It is normally the opening system of the window that determines the hardware required and consequently the mechanism required for the working of the window handle.

Door handles, pull handles and window handles are often incorrectly used, damaging the product and the quality standard defined by the producer.

Common errors include:

The use of the handle as a support or hook for objects which may be excessively heavy.

The use of the handle as a plaything by children.

The use of the handle as a doorstop against the wall.

Valli&Valli products do not require excessive maintenance. For care and cleaning, except in those cases where a specific product is recommended for certain finishes, Valli&Valli recommends the use of just a soft dry cloth.

To ensure correct installation, the instructions contained in the box should be followed.

If necessary consult the retailer or specialized personnel.

In the case of products in glass or porcelain together with brass, it should be remembered that these fragile materials are liable to break if used incorrectly.

Valli&Valli recommends the use of doorstops fixed to the floor or the wall close to the door or its handle.

On all products with a grab screw Valli&Valli recommends the use of a retaining compound.

It is also advisable to check the position and tightness of all fixing elements at regular intervals.

The user/purchaser of the product should ask the retailer for instructions regarding the correct installation, care and maintenance of the product.

Valli&Valli products are subject to a continual process of development and updating, and production is constantly monitored by Valli&Valli Quality Assurance.

Most Valli&Valli products are "tools" for opening and closing doors and windows.

Inevitably, as with all artifacts, depending on the material of which they are made and where they are made and where they are used, they are subject to wear and then passing of time.

Brass, an alloy subject to oxidation, has to be covered with a protective coating if its appearance is to remain unchanged over time.

Care should be taken during use and maintenance, as improper use or poor maintenance could damage the protective coating, permitting corrosion and consequently causing an anti-aesthetic appearance.

Stainless steel is generally considered to be indestructible.

However, even this material can show the occasional scratch or spot of rust.

Such rust-spots are so-called "surface ruse", and can be removed using an appropriate cleaner, available from specialized retailers.

The manufacturer cannot be held responsible for damage due to normal wear and tear, incorrect treatment, installation or maintenance or non-observance of the above warnings.

# Valli&Valli

Headquarter/Showroom  
Valli&Valli (U.S.A.) Inc.  
Architects and Designers Building  
964 Third Ave., Suite 563/Annex  
New York, NY 10155  
Tel. (212) 326 8811  
Fax (212) 326 8816  
Toll Free (877) 326 2565  
Toll Free (800) 423 7161  
E-mail: sales@vallivalli-us.com  
E-mail: w.sales@vallivalli-us.com

Warehouse  
Valli&Valli (U.S.A.) Inc.  
100 Commerce Way, Suite 2  
Hackensack, NJ 07601  
Tel. (973) 249 0085  
Fax (973) 249 0135

Italian commercial office  
Ufficio commerciale Italia

Tel. +39 0362 982271  
Fax +39 0362 982235  
vendite.italia@assaabloy.it

Export office/Ufficio Export

Tel. +39 0362 982260  
Fax +39 0362 924455  
export@assaabloy.it

Showroom  
New York  
Architects and Designers Building  
964 Third Ave., Suite 563/Annex  
New York, NY 10155  
Tel. (212) 326 8811  
Fax (212) 326 8816

Factory/Stabilimento

20838 Renate (MB) Italy  
Via Concordia, 16

[www.vallivalli-us.com](http://www.vallivalli-us.com)  
[www.assaabloy.com](http://www.assaabloy.com)